

TIMING PULLEYS

POULIES DENTÉES

ZAHN-SCHEIBEN

POLEAS DENTADAS

GENERALITY

This catalogue is a synthesis of the whole SIT range of timing pulleys.

GÉNÉRALITÉ

Ce catalogue est une synthèse de l'entière gamme SIT des poulies dentées.

ALLGEMEINES

In diesem Katalog ist die ganze Reihe der SIT Zahnscheiben beschrieben.

GENERALIDAD

Este catálogo es una síntesis de la gama completa de las poleas dentadas SIT.



Timing pulleys pitches Les pas des poulies dentées Zahnscheiben teilungen Paso de las poleas dentadas

type Type Typ tipos		MXL	XL	L	H	XH	XXH	Super Torque:				T2,5	T5	T10	T20	
								S 4,5 M	S 8 M	S 14 M						
								TOP DRIVE® HTD:				AT5		AT10		
								3 M	5 M	8 M	14 M					
pitch	mm	2,032	5,080	9,525	12,700	22,225	31,750	3	4,5	5	8	14	2,5	5	10	20
pas	inches	0,080	0,200	0,375	0,500	0,875	1,250	-	-	-	-	-	-	-	-	-
Teilung								-	-	-	-	-	-	-	-	-
paso		(2/25)	(1/5)	(3/8)	(1/2)	(7/8)	(1 1/2)	-	-	-	-	-	-	-	-	-

Pulley identification

SIT Timing pulleys are indicated by a conventional code consisting of 3 groups. The first group shows number of teeth. The second group shows the pitch (stated at the beginning of each table). The third group shows the belt width for which the pulley has to be used:

- for XL, L, H, XH and XXH pulleys the belt width is in hundred of an inch (100 = 1 inch)
- for Super Torque, TOP DRIVE® HTD, T2,5, T5 and T10 pulleys the belt width is in mm.

In case of timing pulley for assembly with SER-SIT® conical bush, the previous conventional code must be preceded by the letter "B".

Example:

B	28	L	050
pulley for Ser-Sit® bush	n. teeth	pitch (1/2")	belt width

Designation des poulies

Les poulies dentées de série sont désignées par un code conventionnel, formé de 3 groupes.

Le premier indique le nombre de dents. Le deuxième indique le pas (en tête de chaque tableau). La troisième groupe indique la largeur de la courroie pour laquelle la poulie doit être utilisée:

- pour les poulies XL, L, H, XH et XXH la largeur de la courroie est indiquée en pouce (100 = 1 pouce);
- pour les poulies Super Torque, TOP DRIVE® HTD T2,5, T5, T10, la largeur de la courroie est indiquée en mm.

En cas de poulies dentées pour montage avec moyen amovible SER SIT®, le code conventionnel précédent doit être précédé par la lettre "B".

Example:

B	28	L	050
poulie pour moyen amovible Ser-Sit®	dents	pas (1/2")	largeur de la courroie (1/2")

Kennzeichen

Das konventionelle Kennzeichen für SIT Zahnscheiben soll wie folgt interpretiert werden.

Die erste Zahlengruppe zeigt die Zähneanzahl. Die zweite Buchstaben/Zahlengruppe zeigt die Teilung (am Kopf von jeden Tabelle gezeigt).

Die dritte Zahlengruppe zeigt die Breite des Riemens wofür die scheiben geeignet sind, wie folgt:

- für XL, L, H, XH und XXH Scheiben die Breite ist in Hundertstel Zoll gezeigt (100=1 Zoll);
- für Super Torque, TOP DRIVE® HTD, T2,5, T5, T10 Scheiben, die Breite ist in mm gezeigt.

Falls die Scheiben mit SER SIT® Spannbuchsen ansgerüstet sind, das Kennzeichen wird ein "B" am Anfang haben.

Beispiel:

B	28	L	050
Spannbuchse Ser-Sit®	Zähneanzahl	Teilung (1/2" Zoll)	riemenbreite (1/2" Zoll)

Identificacion de las poleas

Las poleas dentadas SIT están referenciadas mediante un código convencional formado por tres grupos.

El primer grupo indica el número de dientes. El segundo indica el paso (tal como se precisa en la cabecera de cada tabla). El tercer grupo indica el ancho de la correa para la cual la polea será utilizada:

- para las poleas XL, L, H, XH, XXH el ancho de la correa se indica en centésimas de pulgada (100=1 pulgada);
- para la polea Super Torque, TOP DRIVE® HTD, T2,5, T5 T10 el ancho de la correa se indica en milímetros. En caso de poleas dentadas con buje conico SER SIT®, el código convencional anteriormente descrito debe ser precedido con la letra "B".

El primer grupo indica el número de dientes. El segundo indica el paso (tal como se precisa en la cabecera de cada tabla). El tercer grupo indica el ancho de la correa para la cual la polea será utilizada:

Ejemplo:

B	28	L	050
Polea para buje cónico Ser-Sit®	número de dientes	paso (1/2")	ancho de la correa (1/2")

PULLEY TOLERANCE DATA

Positive drive pulleys are manufactured according to:
DIN ISO 5294
DIN 7721

TOLERANCES DE FABRICATION DES POULIES

Les poulies dentées sont exécutées selon:
DIN ISO 5294
DIN 7721

DATEN ÜBER DIE ZAHNSCHEIBEN-TOLERANZEN

Die Zahnscheiben werden in engen Toleranzbereichen gefertigt nach:
DIN ISO 5294
DIN 7721

TOLERANCIA DE LAS POLEAS

Las poleas dentadas están fabricadas con mínimas tolerancias secundo:
DIN ISO 5294
DIN 7721

Pulley bore tolerances

On request a tolerance ISO 7 is normally suggested, normally pulleys are bored with H7 tolerance, of not otherwise specified.

Tolérance d'alésage des poulies

La valeur de tolérance conseillée correspond à ISO qualité 7. Lorsqu'il n'y a pas de spécification particulière, les poulies sont fournies avec un alésage tolérance H7.

Zahnscheiben-Bohrungstoleranzen

Der empfohlene Toleranzgrad ist ISO 7. Die Bohrung wird, wenn nicht ausdrücklich anders angegeben, nach Bohrungs-toleranz H7 ausgeführt.

Tolerancia del agujero de la polea

El grado de tolerancia es ISO 7. Si no se especifica lo contrario las poleas se suministran con agujero con tolerancia H7

Eccentricity pulley bore to outside diameter

Tolérances d'excentration entre l'alésage de la poulie et le diamètre extérieur

Zulässige Exzentrizität zwischen Bohrung und Durchmesser

Excentricidad entre el taladro de la polea y el diametro exterior

Outside diameter in mm Diamètre extérieur in mm Außendurchmesser in mm Diámetro exterior in mm	Total eccentricity in mm (dial indicator reading) Excentration maxi (lue an comparateur) mm Max. Exzentrizität (gemessen mit dem Komparator) in mm Excentricidad total (lectura sobre comparador)
up to 254 over 254	0,1270 0,0127 each 25,4 mm diameter
jusq'à 254 au-dessus 254	0,1270 0,0127 par fraction de 25,4 mm
bis 254 über 254	0,1270 0,01270 für je 25,4 mm Durchmesser
hasta 254 otras 254	0,1270 0,01270 por cada 25,4 mm

Lateral oscillation

The pulley bore must be at right angles to the vertical faces of the pulley within 0,0254 mm for each 25,4 mm radius.

Oscillation latérale ou voilage

L'alésage de la poulie doit être perpendiculaire aux faces latérales dans une tolérance de 0,0254 mm par fraction de 25,4 mm de longueur du rayon.

Seitenschlag

Die Zahnscheibenbohrung muß rechtwinklig zu den Zahnscheiben-Flanken ausgeführt sein, d.h. 0,0254 mm für je 25,4 mm Radius.

Oscilación lateral

El taladro de la polea debe ser perpendicular a la cara lateral de la polea. Tolerancia admisible 0,0254 mm por cada 25,4 mm de radio.

STANDARD PULLEYS

These pulleys have equally spaced grooves machined into the outside diameter, to give correct meshing with the belt teeth.

The pulley grooves are of a special design to give this correct meshing of the belt teeth with minimal friction. All pulleys manufactured have correct minimum meshing tolerance built in. The pitch diameter is always larger than the outside diameter. The pulleys are normally stocked in a wide range of various diameters (no. of teeth) and standard widths.

Protective treatment

Pulleys are black phosphated.

Balancing

UNI 4218 – ISO 1940 – VDI 2060

The pulleys for taper bushings (PBD – STB – HDB) are statically balanced within G 16 degree. The pulleys with full hub are not balanced, as they do not have a finished bore.

SPECIAL PULLEYS

Special pulleys with profiles **XL, L, H, XH, XXH, HTD, ST, T, AT** and of every pitch can be manufactured on customer drawing.

It is recommended that the pulleys be made of cast iron or steel. It is essential to use steel when the peripheral speed is over 30 m/s.

TYPES DE SERIE

Ces poulies ont une denture taillée sur le diamètre extérieur, de façon à constituer une liaison parfaite avec les dents de la courroie correspondante.

La denture des poulies est prévue pour un engrènement pratiquement sans friction avec la courroie. Un jeu est prévu entre la denture des poulies et des courroies; d'autre part, le diamètre primitif des poulies est toujours supérieur au diamètre extérieur. Les poulies standard sont tenues en stock dans une importante gamme de diamètres et de largeurs.

Protection traitement

Les poulies sont phosphatées noir.

Equilibrage

UNI 4218 – ISO 1940 – VDI 2060

Dégré d'équilibrage selon G16 pour les poulies par moyeu amovible (PBD – STB – HDB). Les poulies prévues pour des applications standard ne sont pas équilibrées car leur moyeu ne sont pas alésés.

TYPES SPECIAUX

Poulies spéciales avec profile **XL, L, H, XH, XXH, HTD, ST, T, AT** et avec tous pas peuvent être exécutées sur plan. Les poulies dentées sont exécutées en fonte ou en acier lorsque la vitesse circonférentielle est supérieur à 30 m/s.

STANDARD-AUSFÜHRUNG

Die Zahnscheiben erweisen ausgleichmäßig gefräzte Zähne und Zahnücken, so daß eine korrekter Sitz zu den dem entsprechenden Riemenzähnen bestimmt wird.

Die Zahnscheiben sind so konstruiert, daß die Riemenzähne mit unbedeutender Reibung in den Zahngrund ein – bzw. auslaufen können. Alle Lager- oder Bestellung gefertigte Zahnscheiben erweisen ein Minimum an Zahnückenspiel zu dem entsprechenden Riemen. Die Zahnscheiben-Teilkreisdurchmesser sind immer größer als die entsprechenden Außendurchmesser. Sie sind in einer großen Skala von vorrätigen Breiten und Durchmessern erhältlich.

Oberflächenbehandlung

Die Scheiben sind schwarz phosphatiert.

Auswuchtung

UNI 4218 – ISO 1940 – VDI 2060

Unsere Taper Ausführung Scheiben (PBD – STB – HDB) sind statisch ausgewuchtet. Gütestufe G 16. Die ungebohrten Scheiben werden nicht ausgewuchtet, das diese keine Fertigbohrung haben.

SONDERAUSFÜHRUNGEN

Auf Anfrage können wir Zahnscheiben Typ **XL, L, H, XH, XXH, HTD, ST, T, AT** nach Zeichnung herstellen.

Bei diesen Zahnscheiben werden die Gusseisen – sowie die Stahl-Ausführungen empfohlen, letztere insbesondere wenn die Umfangsgeschwindigkeit höher als 30 m/s ist.

POLEAS STANDARD

Estas poleas tienen los tallados longitudinales axiales igualmente espaciados, recortados en su superficie periférica de modo que tenga un acoplamiento correcto con los dientes de la correa al entrar en la ranura correspondiente lo hangan con un rozamiento insignificante. Todas las poleas de stock, o hechas sobre pedido, tienen un mínimo juego de acoplamiento con la correa correspondiente. El diámetro primitivo de la polea es siempre más grande que su diámetro exterior. Normalmente las poleas están en stock en los diversos diámetros (número de dientes) y anchos.

Tratamiento de protección

Las poleas son fosfatadas en negro.

Equilibrado

UNI 4218 – ISO 1940 – VDI 2060

El grado de calidad del equilibrio estático de las poleas para casquillo cónico (PBD – STB – HDB) es G 16. Las poleas para aplicaciones standard no están equilibradas dado que no tienen el taladro terminado.

TIPOS ESPECIALES

Sobre demanda podemos construir poleas dentada **XL, L, H, XH, XXH, HTD, ST, T, AT** bajo plano del cliente.

Se aconseja la ejecución de las poleas dentadas en fundición o acero; particularmente en acero cuando la velocidad periférica es superior a 30 m/s.

$$\left(\begin{array}{l} \text{Peripheral speed m/s} \\ \text{Vitesse circonférentielle en m/s} \\ \text{Umfangsgeschwindigkeit in m/s} \\ \text{Velocidad periferica} \end{array} \right) = \frac{\left(\begin{array}{l} \text{Pulley diamétre in mm x revolution per min} \\ \text{Diametre de la poulie en mm x vitesse en tr/min} \\ \text{Zahnscheibendurchmesser in mm x Drehzahl pro min} \\ \text{Diámetro polea (mm) x r.p.m.} \end{array} \right)}{19100}$$

If weight is a limiting factor, pulleys can also be made in aluminium. However if aluminium is used the pulley will have a shorter life due to the lightly abrasive effect of the nylon cover of the belt. Hard anodising of the teeth is recommended to avoid this trouble.

Pour diminuer le poids d'une transmission, il est possible d'obtenir des poulies en alliage léger; il faut alors tenir compte d'une durée de vie réduite en raison de l'effet d'abrasion de l'armature intérieure en nylon de la courroie. Cet inconvénient peut néanmoins être évité par une oxydation anodique ou un chromage de la denture de la poulie.

Aus Gewichtsgründen können die Zahnscheiben auch als Leichtmetallausführung gefertigt werden; in diesem Falle muß man aber eine kürzere Lebensdauer einkalkulieren denn die Nylon-Gewebebeschichtung der Riemen an der Zahnseite hat eine leichte Abriebwirkung. Um diesem Mangel zu vermeiden ist eine Eloxal- oder Goldeloxalveredelung drigen zu empfehlen.

Por razones de peso pueden también fabricarse en metales ligeros, pero en tal caso hay que preveer una vida más corta de la polea ya que el recubrimiento de nylon de la correa tiene un efecto ligeramente abrasivo. Para evitar este inconveniente se aconseja la oxidación anódica de gran espesor sobre el dentado.

**PITCH AND OUTSIDE DIAMETER
DIAMÈTRE PRIMITIF ET EXTÉRIEUR
WIRK-UND AUBENDURCHMESSER
DIAMETRO PRIMITIVO Y EXTERIOR**

∅ pr. - pitch diameter - diamètre primitif - Wirkdurchmesser - diámetro primitivo
∅ est. - outside diameter - diamètre extérieur - Außendurchmesser - diámetro exterior

MXL (2.032 mm)

mm

Type Type Typ Tipo	∅ pr.	∅ est.	Type Type Typ Tipo	∅ pr.	∅ est.	Type Type Typ Tipo	∅ pr.	∅ est.	Type Type Typ Tipo	∅ pr.	∅ est.	Type Type Typ Tipo	∅ pr.	∅ est.
10 MXL	6,47	5,96	39 MXL	25,23	24,72	67 MXL	43,34	42,83	95 MXL	61,45	60,94	123 MXL	79,56	79,05
11 MXL	7,12	6,61				68 MXL	43,98	43,47	96 MXL	62,09	61,58	124 MXL	80,20	79,69
12 MXL	7,76	7,25	40 MXL	25,87	25,36	69 MXL	44,63	44,12	97 MXL	62,74	62,23	125 MXL	80,85	80,34
13 MXL	8,41	7,90	41 MXL	26,52	26,01				98 MXL	63,39	62,88	126 MXL	81,50	80,99
14 MXL	9,06	8,55	42 MXL	27,17	26,66	70 MXL	45,28	44,77	99 MXL	64,03	63,52	127 MXL	82,14	81,63
15 MXL	9,70	9,19	43 MXL	27,81	27,30	71 MXL	45,92	45,41				128 MXL	82,79	82,28
16 MXL	10,35	9,84	44 MXL	28,46	27,95	72 MXL	46,57	46,06	100 MXL	64,68	64,17	129 MXL	83,44	82,93
17 MXL	11,00	10,49	45 MXL	29,11	28,60	73 MXL	47,22	46,71	101 MXL	65,33	64,82			
18 MXL	11,64	11,13	46 MXL	29,75	29,24	74 MXL	47,86	47,35	102 MXL	65,97	65,46	130 MXL	84,08	83,57
19 MXL	12,29	11,78	47 MXL	30,40	29,89	75 MXL	48,51	48,00	103 MXL	66,62	66,11	131 MXL	84,73	84,22
			48 MXL	31,05	30,54	76 MXL	49,16	48,65	104 MXL	67,27	66,76	132 MXL	85,38	84,87
			49 MXL	31,69	31,18	77 MXL	49,80	49,29	105 MXL	67,91	67,40	133 MXL	86,02	85,51
20 MXL	12,94	12,43				78 MXL	50,45	49,94	106 MXL	68,56	68,05	134 MXL	86,67	86,16
21 MXL	13,58	13,07	50 MXL	32,34	31,83	79 MXL	51,10	50,59	107 MXL	69,21	68,70	135 MXL	87,32	86,81
22 MXL	14,23	13,72	51 MXL	32,99	32,48				108 MXL	69,85	69,34	136 MXL	87,97	87,46
23 MXL	14,88	14,37	52 MXL	33,63	33,12	80 MXL	51,74	51,23	109 MXL	70,50	69,99	137 MXL	88,61	88,10
24 MXL	15,52	15,01	53 MXL	34,28	33,77	81 MXL	52,39	51,88				138 MXL	89,26	88,75
25 MXL	16,17	15,66	54 MXL	34,93	34,42	82 MXL	53,04	52,53	110 MXL	71,15	70,64	139 MXL	89,91	89,40
26 MXL	16,82	16,31	55 MXL	35,57	35,06	83 MXL	53,68	53,17	111 MXL	71,80	71,29			
27 MXL	17,46	16,95	56 MXL	36,22	35,71	84 MXL	54,33	53,82	112 MXL	72,44	71,93	140 MXL	90,55	90,04
28 MXL	18,11	17,60	57 MXL	36,87	36,36	85 MXL	54,98	54,47	113 MXL	73,09	72,58	141 MXL	91,20	90,69
29 MXL	18,76	18,25	58 MXL	37,51	37,00	86 MXL	55,63	55,12	114 MXL	73,74	73,23	142 MXL	91,85	91,34
			59 MXL	38,16	37,65	87 MXL	56,27	55,76	115 MXL	74,38	73,87	143 MXL	92,49	91,98
30 MXL	19,40	18,89				88 MXL	56,92	56,41	116 MXL	75,03	74,52	144 MXL	93,14	92,63
31 MXL	20,05	19,54	60 MXL	38,81	38,30	89 MXL	57,57	57,06	117 MXL	75,68	75,17	145 MXL	93,79	93,28
32 MXL	20,70	20,19	61 MXL	39,46	38,95				118 MXL	76,32	75,81	146 MXL	94,43	93,92
33 MXL	21,34	20,83	62 MXL	40,10	39,59	90 MXL	58,21	57,70	119 MXL	76,97	76,46	147 MXL	95,08	94,57
34 MXL	21,99	21,48	63 MXL	40,75	40,24	91 MXL	58,86	58,36				148 MXL	95,73	95,22
35 MXL	22,64	22,13	64 MXL	41,40	40,89	92 MXL	59,51	59,00	120 MXL	77,62	77,11	149 MXL	96,37	95,86
36 MXL	23,29	22,78	65 MXL	42,04	41,53	93 MXL	60,15	59,64	121 MXL	78,26	77,75			
37 MXL	23,93	23,42	66 MXL	42,69	42,18	94 MXL	60,80	60,29	122 MXL	78,91	78,40	150 MXL	97,02	96,51
38 MXL	24,58	24,07												

XL (5.080 mm)

mm

Type Type Typ Tipo	∅ pr.	∅ est.	Type Type Typ Tipo	∅ pr.	∅ est.	Type Type Typ Tipo	∅ pr.	∅ est.	Type Type Typ Tipo	∅ pr.	∅ est.	Type Type Typ Tipo	∅ pr.	∅ est.
10 XL	16,17	15,66	32 XL	51,74	51,23	54 XL	87,32	86,81	76 XL	122,89	122,38	98 XL	158,47	157,96
11 XL	17,79	17,28	33 XL	53,36	52,85	55 XL	88,93	88,42	77 XL	124,51	124,00	99 XL	160,08	159,57
12 XL	19,40	18,89	34 XL	54,98	54,47	56 XL	90,55	90,04	78 XL	126,13	125,62			
13 XL	21,02	20,51	35 XL	56,60	56,09	57 XL	92,17	91,66	79 XL	127,74	127,23	100 XL	161,70	161,19
14 XL	22,64	22,13	36 XL	58,21	57,70	58 XL	93,79	93,28				101 XL	163,32	162,81
15 XL	24,25	23,74	37 XL	59,83	59,32	59 XL	95,40	94,89	80 XL	129,36	128,85	102 XL	164,93	164,42
16 XL	25,87	25,36	38 XL	61,45	60,94				81 XL	130,98	130,47	103 XL	166,55	166,04
17 XL	27,49	26,98	39 XL	63,06	62,55	60 XL	97,02	96,51	82 XL	132,59	132,08	104 XL	168,17	167,66
18 XL	29,11	28,60				61 XL	98,64	98,13	83 XL	134,21	133,70	105 XL	169,79	169,28
19 XL	30,72	30,21	40 XL	64,88	64,37	62 XL	100,25	99,74	84 XL	135,83	135,32	106 XL	171,40	170,89
			41 XL	66,30	65,79	63 XL	101,87	101,36	85 XL	137,44	136,93	107 XL	173,02	172,51
20 XL	32,34	31,83	42 XL	67,91	67,40	64 XL	103,49	102,98	86 XL	139,06	138,55	108 XL	174,64	174,13
21 XL	33,96	33,45	43 XL	69,53	69,02	65 XL	105,11	104,60	87 XL	140,68	140,17	109 XL	176,25	175,74
22 XL	35,57	35,06	44 XL	71,15	70,64	66 XL	106,72	106,21	88 XL	142,30	141,79			
23 XL	37,19	36,68	45 XL	72,77	72,26	67 XL	108,34	107,83	89 XL	143,91	143,40	110 XL	177,87	177,36
24 XL	38,81	38,30	46 XL	74,38	73,87	68 XL	109,96	109,45				111 XL	179,49	178,98
25 XL	40,43	39,92	47 XL	76,00	75,49	69 XL	111,57	111,06	90 XL	145,53	145,02	112 XL	181,10	180,59
26 XL	42,04	41,53	48 XL	77,62	77,11				91 XL	147,15	146,64	113 XL	182,72	182,21
27 XL	43,66	43,15	49 XL	79,23	78,72	70 XL	113,19	112,68	92 XL	148,76	148,25	114 XL	184,34	183,83
28 XL	45,28	44,77				71 XL	114,81	114,30	93 XL	150,38	149,87	115 XL	185,95	185,44
29 XL	46,89	46,38	50 XL	80,85	80,34	72 XL	116,43	115,92	94 XL	152,00	151,49	116 XL	187,57	187,06
			51 XL	82,47	81,96	73 XL	118,04	117,53	95 XL	153,62	153,11	117 XL	189,19	188,68
30 XL	48,51	48,00	52 XL	84,08	83,57	74 XL	119,66	119,15	96 XL	155,23	154,72	118 XL	190,81	190,30
31 XL	50,13	49,62	53 XL	85,70	85,19	75 XL	121,28	120,77	97 XL	156,85	156,34	119 XL	192,42	191,91
												120 XL	194,04	193,53

L (9.525 mm)

mm

Type Type Typ Tipo	∅ pr.	∅ est.	Type Type Typ Tipo	∅ pr.	∅ est.	Type Type Typ Tipo	∅ pr.	∅ est.	Type Type Typ Tipo	∅ pr.	∅ est.	Type Type Typ Tipo	∅ pr.	∅ est.
10 L	30,32	29,56	33 L	100,05	99,29	56 L	169,79	169,02	79 L	239,52	238,76	101 L	306,22	305,46
11 L	33,35	32,59	34 L	103,08	102,32	57 L	172,82	172,06				102 L	309,25	308,49
12 L	36,38	35,62	35 L	106,12	105,35	58 L	175,85	175,09	80 L	242,55	241,79	103 L	312,29	311,53
13 L	39,41	38,65	36 L	109,15	108,39	59 L	178,88	178,12	81 L	245,58	244,82	104 L	315,32	314,56
14 L	42,45	41,69	37 L	112,18	111,42				82 L	248,62	247,86	105 L	318,35	317,59
15 L	45,48	44,72	38 L	115,21	114,45	60 L	181,91	181,15	83 L	251,65	250,89	106 L	321,38	320,62
16 L	48,51	47,75	39 L	118,24	117,48	61 L	184,95	184,19	84 L	254,68	253,92	107 L	324,41	323,65
17 L	51,54	50,78				62 L	187,98	187,22	85 L	257,71	256,95	108 L	327,44	326,68
18 L	54,57	53,81	40 L	121,28	120,52	63 L	191,01	190,25	86 L	260,74	259,98	109 L	330,48	329,72
19 L	57,61	56,84	41 L	124,31	123,55	64 L	194,04	193,28	87 L	263,77	263,01			
			42 L	127,34	126,58	65 L	197,07	196,31	88 L	266,80	266,04	110 L	333,51	332,75
20 L	60,64	59,88	43 L	130,37	129,61	66 L	200,11	199,34	89 L	269,83	269,07	111 L	336,54	335,78
21 L	63,67	62,91	44 L	133,40	132,64	67 L	203,14	202,38				112 L	339,57	338,81
22 L	66,70	65,94	45 L	136,44	135,67	68 L	206,17	205,41	90 L	282,87	282,11	113 L	342,61	341,85
23 L	69,73	68,97	46 L	139,47	138,71	69 L	209,20	208,44	91 L	275,90	275,14	114 L	345,64	344,88
24 L	72,77	72,01	47 L	142,50	141,74				92 L	278,94	278,18	115 L	348,67	347,91
25 L	75,80	75,04	48 L	145,53	144,77	70 L	212,23	211,47	93 L	281,97	281,21	116 L	351,70	350,94
26 L	78,83	78,07	49 L	148,56	147,80	71 L	215,27	214,51	94 L	285,00	284,24	117 L	354,73	353,97
27 L	81,86	81,10				72 L	218,30	217,54	95 L	288,03	287,27	118 L	357,76	357,00
28 L	84,89	84,13	50 L	151,60	150,83	73 L	221,33	220,57	96 L	291,06	290,30	119 L	360,80	360,04
29 L	87,93	87,16	51 L	154,63	153,87	74 L	224,36	223,60	97 L	294,09	293,33			
			52 L	157,66	156,90	75 L	227,39	226,63	98 L	297,13	296,37	120 L	363,83	363,07
30 L	90,96													

H (12.700 mm)

mm

Type Type Typ Tipo	Ø pr.	Ø est.	Type Type Typ Tipo	Ø pr.	Ø est.	Type Type Typ Tipo	Ø pr.	Ø est.	Type Type Typ Tipo	Ø pr.	Ø est.	Type Type Typ Tipo	Ø pr.	Ø est.
14 H	56,60	55,23	37 H	149,57	148,20	60 H	242,55	241,18	83 H	335,53	334,16	106 H	428,51	427,14
15 H	60,64	59,27	38 H	153,62	152,25	61 H	246,59	245,22	84 H	339,57	338,20	107 H	432,55	431,17
16 H	64,68	63,31	39 H	157,66	156,29	62 H	250,64	249,27	85 H	343,61	342,24	108 H	436,59	435,22
17 H	68,72	67,35				63 H	254,68	253,31	86 H	347,66	346,29	109 H	440,63	439,26
18 H	72,77	71,40	40 H	161,70	160,33	64 H	258,72	257,35	87 H	351,70	350,33			
19 H	76,81	75,44	41 H	165,74	164,37	65 H	262,76	261,39	88 H	355,74	354,37	110 H	414,68	443,31
			42 H	169,79	168,42	66 H	266,81	165,44	89 H	359,78	358,41	111 H	448,72	447,35
20 H	80,85	79,48	43 H	173,83	172,46	67 H	270,85	269,48				112 H	452,76	451,39
21 H	84,89	83,52	44 H	177,87	176,50	68 H	274,89	273,52	90 H	363,83	362,46	113 H	456,80	455,43
22 H	88,94	87,57	45 H	181,91	180,54	69 H	278,93	277,57	91 H	367,87	366,50	114 H	460,85	459,48
23 H	92,98	91,61	46 H	185,96	184,59				92 H	371,91	270,54	115 H	464,89	463,52
24 H	97,02	95,65	47 H	190,00	188,63	70 H	282,98	281,61	93 H	375,95	374,58	116 H	468,93	467,56
25 H	101,06	99,69	48 H	194,04	192,67	71 H	287,02	285,65	94 H	380,00	378,63	117 H	472,97	471,60
26 H	105,11	103,74	49 H	198,08	196,71	72 H	291,06	289,69	95 H	384,04	382,67	118 H	477,02	475,65
27 H	109,15	107,78				73 H	295,10	293,73	96 H	388,08	386,71	119 H	481,06	479,69
28 H	113,19	111,82	50 H	202,13	200,76	74 H	299,15	297,78	97 H	392,12	290,75			
29 H	117,23	115,86	51 H	206,17	204,80	75 H	303,19	301,82	98 H	396,17	394,80	120 H	485,10	483,73
			52 H	210,21	208,84	76 H	307,23	305,86	99 H	400,21	398,84	125 H	505,31	503,94
30 H	121,28	119,91	53 H	214,25	212,88	77 H	311,27	309,90				130 H	525,53	524,16
31 H	125,32	123,95	54 H	218,30	216,93	78 H	315,32	313,95	100 H	404,25	402,88	135 H	545,74	544,37
32 H	129,36	127,99	55 H	222,34	220,97	79 H	319,36	317,99	101 H	408,29	406,92	140 H	565,95	564,58
33 H	133,40	132,03	56 H	226,38	225,01				102 H	412,34	410,97	145 H	586,16	584,79
34 H	137,45	136,08	57 H	230,42	229,05	80 H	323,40	322,03	103 H	416,38	415,01	150 H	606,38	605,01
35 H	141,49	140,12	58 H	234,47	233,10	81 H	327,44	326,07	104 H	420,42	419,05	156 H	630,63	629,26
36 H	145,53	144,16	59 H	238,51	237,14	82 H	331,49	330,12	105 H	424,46	423,09			

XH (22.225 mm)

mm

Type Type Typ Tipo	Ø pr.	Ø est.	Type Type Typ Tipo	Ø pr.	Ø est.	Type Type Typ Tipo	Ø pr.	Ø est.	Type Type Typ Tipo	Ø pr.	Ø est.	Type Type Typ Tipo	Ø pr.	Ø est.
18 XH	127,34	124,55	42 XH	297,13	294,34	67 XH	473,99	471,20	91 XH	643,77	640,98	116 XH	820,63	817,84
19 XH	134,41	121,62	43 XH	304,20	301,41	68 XH	481,06	478,27	92 XH	650,85	648,06	117 XH	827,71	924,92
			44 XH	311,27	308,48	69 XH	488,13	485,34	93 XH	657,92	655,13	118 XH	834,78	831,99
20 XH	141,49	138,70	45 XH	318,35	315,56				94 XH	664,99	662,20	119 XH	841,85	839,06
21 XH	148,56	145,77	46 XH	325,42	322,63	70 XH	495,21	492,42	95 XH	672,07	669,28			
22 XH	156,64	152,85	47 XH	332,50	329,71	71 XH	502,28	499,49	96 XH	679,14	676,35	120 XH	848,93	846,14
23 XH	162,71	159,92	48 XH	339,57	336,78	72 XH	509,36	506,57	97 XH	686,22	683,43	122 XH	863,08	860,29
24 XH	169,79	167,00	49 XH	346,66	343,87	73 XH	516,43	513,64	98 XH	693,29	690,50	124 XH	877,23	874,44
25 XH	176,86	174,07				74 XH	523,51	520,72	99 XH	700,37	697,58	125 XH	884,30	881,51
26 XH	183,94	181,15	50 XH	353,72	350,93	75 XH	530,58	527,79				126 XH	891,37	888,58
27 XH	191,01	188,22	51 XH	360,79	358,00	76 XH	537,65	534,86	100 XH	707,44	704,65	128 XH	905,52	902,73
28 XH	198,08	195,29	52 XH	367,87	365,08	77 XH	544,73	541,94	101 XH	714,51	711,72	130 XH	919,67	916,88
29 XH	205,16	202,37	53 XH	374,94	372,15	78 XH	551,80	549,01	102 XH	721,59	718,77	132 XH	933,82	931,03
			54 XH	382,02	379,23	79 XH	558,88	556,09	103 XH	728,66	725,87	134 XH	947,97	945,18
30 XH	212,23	209,44	55 XH	389,09	386,30				104 XH	735,74	732,95	135 XH	955,04	952,25
31 XH	219,31	216,52	56 XH	396,17	393,38	80 XH	565,95	563,16	105 XH	742,81	740,02	136 XH	962,12	959,33
32 XH	226,38	223,59	57 XH	403,24	400,45	81 XH	573,03	570,24	106 XH	749,89	747,10	138 XH	976,27	973,48
33 XH	233,46	230,67	58 XH	410,32	407,53	82 XH	580,10	577,31	107 XH	756,96	754,17			
34 XH	240,53	237,74	59 XH	417,39	414,60	83 XH	587,18	584,39	108 XH	764,04	761,25	140 XH	990,42	987,63
35 XH	247,60	244,81				84 XH	594,25	591,46	109 XH	771,11	768,32	142 XH	1004,57	1001,78
36 XH	254,68	251,89	60 XH	424,47	421,68	85 XH	601,32	598,53				144 XH	1018,71	1015,92
37 XH	261,75	258,96	61 XH	431,54	428,75	86 XH	608,40	605,61	110 XH	778,18	775,39	146 XH	1032,86	1030,07
38 XH	268,83	266,04	62 XH	438,61	435,82	87 XH	615,47	612,68	111 XH	785,26	782,47	148 XH	1047,01	1044,22
39 XH	275,90	273,11	63 XH	445,69	442,90	88 XH	622,55	619,76	112 XH	792,33	789,54	150 XH	1061,16	1058,37
			64 XH	452,76	449,97	89 XH	629,62	626,83	113 XH	799,41	796,62			
40 XH	282,98	280,19	65 XH	459,84	457,05				114 XH	806,48	803,69			
41 XH	290,05	287,26	66 XH	466,91	464,12	90 XH	636,70	633,91	115 XH	813,56	810,77			

XXH (31,750 mm)

mm

Type Type Typ Tipo	Ø pr.	Ø est.	Type Type Typ Tipo	Ø pr.	Ø est.	Type Type Typ Tipo	Ø pr.	Ø est.	Type Type Typ Tipo	Ø pr.	Ø est.	Type Type Typ Tipo	Ø pr.	Ø est.
18 XXH	181,91	178,86	39 XXH	394,15	391,10	60 XXH	606,38	603,33	81 XXH	818,61	815,66	102 XXH	1030,84	1027,79
19 XXH	192,02	188,97				61 XXH	616,48	613,43	82 XXH	828,72	825,67	103 XXH	1040,95	1037,90
			40 XXH	404,25	401,20	62 XXH	626,59	623,54	83 XXH	838,82	835,77	104 XXH	1051,06	1048,01
20 XXH	202,13	199,08	41 XXH	414,36	411,31	63 XXH	636,70	633,65	84 XXH	848,93	845,88	105 XXH	1061,16	1058,11
21 XXH	212,23	209,18	42 XXH	424,47	421,42	64 XXH	646,80	643,75	85 XXH	859,04	855,99	106 XXH	1071,27	1068,22
22 XXH	222,34	219,29	43 XXH	434,57	431,52	65 XXH	656,91	653,86	86 XXH	869,14	866,09	107 XXH	1081,37	1078,32
23 XXH	232,45	229,40	44 XXH	444,68	441,63	66 XXH	667,02	663,97	87 XXH	879,25	876,20	108 XXH	1091,48	1088,43
24 XXH	242,55	239,50	45 XXH	454,78	451,73	67 XXH	677,12	674,07	88 XXH	889,35	886,30	109 XXH	1101,59	1098,54
25 XXH	252,66	249,61	46 XXH	464,89	461,84	68 XXH	687,23	684,18	89 XXH	899,46	896,41			
26 XXH	262,76	259,71	47 XXH	475,00	471,95							110 XXH	1111,69	1108,64
27 XXH	272,87	269,82	48 XXH	485,10	482,05	70 XXH	707,44	704,39	91 XXH	919,67	916,62	111 XXH	1121,80	1118,75
28 XXH	282,98	279,93	49 XXH	495,21	492,16	71 XXH	717,55	714,50	92 XXH	929,78	926,73	112 XXH	1131,91	1128,86
29 XXH	293,08	290,03				72 XXH	727,66	724,61	93 XXH	939,89	936,84	113 XXH	1142,01	1138,96
			50 XXH	505,32	502,27	73 XXH	737,77	734,72	94 XXH	949,99	946,94	114 XXH	1152,12	1149,07
30 XXH	303,19	300,14	51 XXH	515,42	512,37	74 XXH	747,87	744,82	95 XXH	960,10	957,05	115 XXH	1162,23	1159,18
31 XXH	313,30	310,25	52 XXH	525,53	522,48	75 XXH	757,97	754,92	96 XXH	970,21	967,16	116 XXH	1172,33	1169,28
32 XXH	323,40	320,35	53 XXH	535,63	532,58	76 XXH	768,08	765,03	97 XXH	980,31	977,26	117 XXH	1182,44	1179,39
33 XXH	333,51	330,46	54 XXH	545,74	542,69	77 XXH	778,19	775,14	98 XXH	990,42	987,37	118 XXH	1192,54	1189,49
34 XXH	343,62	340,57	55 XXH	555,85	552,80	78 XXH	788,29	785,24	99 XXH	1000,52	997,47	119 XXH	1202,65	1199,60
35 XXH	353,72	350,67	56 XXH	565,95	562,90									
36 XXH	363,83	360,78	57 XXH	576,06	573,01	79 XXH	798,40	795,35				120 XXH	1212,76	1209,71
37 XXH	373,93	370,88	58 XXH	586,17	583,12				100 XXH	1010,63	1007,58			
38 XXH	384,04	380,99	59 XXH	596,27	593,22	80 XXH	808,50	805,45	101 XXH	1020,74	1017,69			



SUPER TORQUE

S 4,5 M (4,5 mm)

mm

Type Type Typ Tipo	Ø pr.	Ø est.	Type Type Typ Tipo	Ø pr.	Ø est.	Type Type Typ Tipo	Ø pr.	Ø est.	Type Type Typ Tipo	Ø pr.	Ø est.	Type Type Typ Tipo	Ø pr.	Ø est.
16 S4,5M	22,92	22,16	30 S4,5M	42,97	42,21	45 S4,5M	64,46	63,70	60 S4,5M	85,95	85,19	75 S4,5M	107,44	106,68
17 S4,5M	24,35	23,59	31 S4,5M	44,40	43,64	46 S4,5M	65,89	65,13	61 S4,5M	87,38	86,62	76 S4,5M	108,87	108,11
18 S4,5M	25,78	25,02	32 S4,5M	45,84	45,08	47 S4,5M	67,33	66,57	62 S4,5M	88,81	88,05	77 S4,5M	110,30	109,54
19 S4,5M	27,21	26,45	33 S4,5M	47,27	46,51	48 S4,5M	68,76	68,00	63 S4,5M	90,25	89,49	78 S4,5M	111,74	110,98
			34 S4,5M	48,70	47,94	49 S4,5M	70,19	69,43	64 S4,5M	91,68	90,92	79 S4,5M	113,17	112,41
20 S4,5M	28,65	27,89	35 S4,5M	50,13	49,37				65 S4,5M	93,11	92,35			
21 S4,5M	30,08	29,32	36 S4,5M	51,57	50,81	50 S4,5M	71,62	70,86	66 S4,5M	94,54	93,78	80 S4,5M	114,60	113,84
22 S4,5M	31,51	30,75	37 S4,5M	53,00	52,24	51 S4,5M	73,06	72,30	67 S4,5M	95,98	95,22	81 S4,5M	116,03	115,27
23 S4,5M	32,94	32,18	38 S4,5M	54,43	53,67	52 S4,5M	74,49	73,73	68 S4,5M	97,41	96,65	82 S4,5M	117,47	116,71
24 S4,5M	34,38	33,62	39 S4,5M	55,86	55,10	53 S4,5M	75,92	75,16	69 S4,5M	98,84	98,08	83 S4,5M	118,90	118,14
25 S4,5M	35,81	35,05				54 S4,5M	77,35	76,59				84 S4,5M	120,33	119,57
26 S4,5M	37,24	36,48	40 S4,5M	57,30	56,54	55 S4,5M	78,79	78,03	70 S4,5M	100,27	99,51	85 S4,5M	121,76	121,00
27 S4,5M	38,67	37,91	41 S4,5M	58,73	57,97	56 S4,5M	80,22	79,46	71 S4,5M	101,71	100,95	86 S4,5M	123,20	122,44
28 S4,5M	40,11	39,35	42 S4,5M	60,16	59,40	57 S4,5M	81,65	80,89	72 S4,5M	103,14	102,38	87 S4,5M	124,63	123,87
29 S4,5M	41,54	40,78	43 S4,5M	61,60	60,84	58 S4,5M	83,08	82,32	73 S4,5M	104,57	103,81	88 S4,5M	126,06	125,30
			44 S4,5M	63,03	62,27	59 S4,5M	84,52	83,76	74 S4,5M	106,01	105,25	89 S4,5M	127,49	126,73

S 8 M (8 mm)

mm

Type Type Typ Tipo	Ø pr.	Ø est.	Type Type Typ Tipo	Ø pr.	Ø est.	Type Type Typ Tipo	Ø pr.	Ø est.	Type Type Typ Tipo	Ø pr.	Ø est.	Type Type Typ Tipo	Ø pr.	Ø est.
18 S8M	45,84	44,47	53 S8M	134,96	133,59	89 S8M	226,64	225,27	124 S8M	315,76	314,39	160 S8M	407,44	400,97
19 S8M	48,38	47,01	54 S8M	137,51	136,14				125 S8M	318,31	316,94	161 S8M	409,98	408,61
			55 S8M	140,06	138,68	90 S8M	229,18	227,81	126 S8M	320,86	319,48	162 S8M	412,53	411,16
20 S8M	50,93	49,56	56 S8M	142,60	141,23	91 S8M	231,73	230,36	127 S8M	323,41	322,03	163 S8M	415,08	413,70
21 S8M	53,48	52,11	57 S8M	145,15	143,78	92 S8M	234,28	232,90	128 S8M	325,95	324,58	164 S8M	417,62	416,25
22 S8M	56,02	54,65	58 S8M	147,70	146,32	93 S8M	236,82	235,45	129 S8M	328,50	327,12	165 S8M	420,17	418,80
23 S8M	58,57	57,20	59 S8M	150,24	148,87	94 S8M	239,37	238,00				166 S8M	422,72	421,34
24 S8M	61,12	59,75				95 S8M	241,92	240,54	130 S8M	331,04	329,67	167 S8M	425,26	423,89
25 S8M	63,66	62,29	60 S8M	152,79	151,42	96 S8M	244,46	243,09	131 S8M	333,59	332,22	168 S8M	427,81	426,44
26 S8M	66,21	64,84	61 S8M	155,34	153,96	97 S8M	247,01	245,64	132 S8M	336,14	334,76	169 S8M	430,25	428,98
27 S8M	68,75	67,38	62 S8M	157,88	156,51	98 S8M	249,55	248,18	133 S8M	338,68	337,31			
28 S8M	71,30	70,08	63 S8M	160,43	159,06	99 S8M	252,10	250,73	134 S8M	341,23	339,86	170 S8M	432,90	431,53
29 S8M	73,85	72,62	64 S8M	162,97	161,60				135 S8M	343,77	342,40	171 S8M	435,45	434,08
			65 S8M	165,52	164,15	100 S8M	254,65	253,28	136 S8M	346,32	344,95	172 S8M	437,99	436,62
30 S8M	76,39	75,13	66 S8M	168,07	166,70	101 S8M	257,19	255,82	137 S8M	348,87	347,50	173 S8M	440,54	439,17
31 S8M	78,94	77,65	67 S8M	170,61	169,24	102 S8M	259,74	258,37	138 S8M	351,41	350,04	174 S8M	443,09	441,72
32 S8M	81,49	80,15	68 S8M	173,16	171,79	103 S8M	262,29	260,92	139 S8M	353,96	352,59	175 S8M	445,63	444,26
33 S8M	84,03	82,68	69 S8M	175,71	174,34	104 S8M	264,83	263,46				176 S8M	448,18	446,81
34 S8M	86,58	85,22				105 S8M	267,38	266,01	140 S8M	356,51	355,14	177 S8M	450,73	449,36
35 S8M	89,13	87,76	70 S8M	178,25	176,88	106 S8M	269,93	268,56	141 S8M	359,05	357,68	178 S8M	453,27	451,90
36 S8M	91,67	90,30	71 S8M	180,80	179,43	107 S8M	272,47	271,10	142 S8M	361,60	360,23	179 S8M	455,82	454,45
37 S8M	94,22	92,85	72 S8M	183,35	181,97	108 S8M	275,02	273,65	143 S8M	364,15	362,78			
38 S8M	96,77	95,39	73 S8M	185,89	184,52	109 S8M	277,57	276,19	144 S8M	366,69	365,32	180 S8M	458,37	456,99
39 S8M	99,31	97,94	74 S8M	188,44	187,07				145 S8M	369,24	367,87	181 S8M	460,91	459,54
			75 S8M	190,99	189,61	110 S8M	280,11	278,74	146 S8M	371,79	370,41	182 S8M	463,46	462,09
40 S8M	101,86	100,49	76 S8M	193,53	192,16	111 S8M	282,66	281,29	147 S8M	374,33	372,96	183 S8M	466,01	464,63
41 S8M	104,41	103,03	77 S8M	196,08	194,71	112 S8M	285,21	283,83	148 S8M	376,88	375,51	184 S8M	468,55	467,18
42 S8M	106,95	105,58	78 S8M	198,63	197,25	113 S8M	287,75	286,38	149 S8M	379,43	378,05	185 S8M	471,10	469,73
43 S8M	109,50	108,13	79 S8M	201,17	199,81	114 S8M	290,30	288,93				186 S8M	473,65	472,27
44 S8M	112,05	110,67				115 S8M	292,85	291,47	150 S8M	381,97	380,60	187 S8M	476,19	474,82
45 S8M	114,59	113,22	80 S8M	203,72	202,35	116 S8M	295,39	294,02	151 S8M	384,52	383,15	188 S8M	478,74	477,37
46 S8M	117,14	115,77	81 S8M	206,26	204,89	117 S8M	297,94	296,57	152 S8M	387,06	385,70	189 S8M	481,28	479,91
47 S8M	119,68	118,31	82 S8M	208,81	207,44	118 S8M	300,48	299,11	153 S8M	389,61	388,24			
48 S8M	122,23	120,86	83 S8M	211,36	209,99	119 S8M	303,03	301,66	154 S8M	392,16	390,79	190 S8M	483,83	482,46
49 S8M	124,78	123,41	84 S8M	213,90	212,53				155 S8M	394,70	393,33	191 S8M	486,38	485,01
			85 S8M	216,45	215,08	120 S8M	305,58	304,21	156 S8M	397,25	395,88	192 S8M	488,92	487,55
50 S8M	127,32	125,95	86 S8M	219,00	217,63	121 S8M	308,12	306,75	157 S8M	399,80	398,43			
51 S8M	129,87	128,50	87 S8M	221,54	220,17	122 S8M	310,67	309,30	158 S8M	402,34	400,97			
52 S8M	132,42	131,05	88 S8M	224,09	222,72	123 S8M	313,22	311,85	159 S8M	404,89	403,52			

S 14 M (14 mm)

mm

Type Type Typ Tipo	Ø pr.	Ø est.	Type Type Typ Tipo	Ø pr.	Ø est.	Type Type Typ Tipo	Ø pr.	Ø est.	Type Type Typ Tipo	Ø pr.	Ø est.	Type Type Typ Tipo	Ø pr.	Ø est.
28 S14M	124,78	121,98	60 S14M	267,38	264,59	93 S14M	414,44	411,74	126 S14M	561,50	558,70	159 S14M	708,56	705,76
29 S14M	129,33	126,44	61 S14M	271,84	269,04	94 S14M	418,90	416,10	127 S14M	565,95	563,16	160 S14M	713,01	710,22
			62 S14M	276,29	273,50	95 S14M	423,35	420,56	128 S14M	570,41	567,62	161 S14M	717,47	714,68
30 S14M	133,69	130,90	63 S14M	280,75	277,95	96 S14M	427,81	425,01	129 S14M	574,87	572,07	162 S14M	721,93	719,13
31 S14M	138,15	135,35	64 S14M	285,21	282,41	97 S14M	432,26	429,47				163 S14M	726,38	723,59
32 S14M	142,60	139,81	65 S14M	289,66	286,87	98 S14M	436,72	433,93	130 S14M	579,32	576,53	164 S14M	730,84	728,05
33 S14M	147,06	144,26	66 S14M	294,12	291,32	99 S14M	441,18	438,38	131 S14M	583,78	580,99	165 S14M	735,30	732,50
34 S14M	151,51	148,72	67 S14M	298,57	295,78				132 S14M	588,24	585,44	166 S14M	739,75	736,96
35 S14M	155,98	153,18	68 S14M	303,03	300,24	100 S14M	445,63	442,84	133 S14M	592,69	589,90	167 S14M	744,21	741,41
36 S14M	160,43	157,63	69 S14M	307,49	304,69	101 S14M	450,09	447,30	134 S14M	597,15	594,35	168 S14M	748,66	745,87
37 S14M	164,88	162,09				102 S14M	454,55	451,75	135 S14M	601,61	598,81	169 S14M	753,12	750,33
38 S14M	169,34	166,55	70 S14M	311,94	309,15	103 S14M	459,00	456,21	136 S14M	606,06	603,27	170 S14M	757,58	754,78
39 S14M	173,80	171,00	71 S14M	316,40	313,61	104 S14M	463,46	460,66	137 S14M	610,52	607,72	171 S14M	762,03	759,24
			72 S14M	320,86	318,06	105 S14M	467,92	465,12	138 S14M	614,97	612,18	172 S14M	766,49	763,70
40 S14M	178,25	175,46	73 S14M	325,31	322,52	106 S14M	472,37	469,58	139 S14M	619,43	616,64	173 S14M	770,95	768,15
41 S14M	182,71	179,92	74 S14M	329,77	326,97	107 S14M	476,83	474,03	140 S14M	623,89	621,09	174 S14M	775,40	772,61
42 S14M	187,17	184,37	75 S14M	334,22	331,43	108 S14M	481,28	478,49	141 S14M	628,34	625,55	175 S14M		

TOP DRIVE® HTD

5 M (5 mm)

mm

Type Type Tipo	Ø pr.	Ø est.	Type Type Tipo	Ø pr.	Ø est.	Type Type Tipo	Ø pr.	Ø est.	Type Type Tipo	Ø pr.	Ø est.	Type Type Tipo	Ø pr.	Ø est.
13 - 5M	20,69	19,55	43 - 5M	68,44	67,30	73 - 5M	116,18	115,04	103 - 5M	163,93	162,79	133 - 5M	211,68	210,54
14 - 5M	22,28	21,14	44 - 5M	70,03	68,89	74 - 5M	117,77	116,63	104 - 5M	165,52	164,38	134 - 5M	213,27	212,13
15 - 5M	23,87	22,73	45 - 5M	71,62	70,48	75 - 5M	119,37	118,23	105 - 5M	167,11	165,97	135 - 5M	214,86	213,72
16 - 5M	25,46	24,32	46 - 5M	73,21	72,07	76 - 5M	120,96	119,82	106 - 5M	168,70	167,56	136 - 5M	216,45	215,31
17 - 5M	27,06	25,92	47 - 5M	74,80	73,66	77 - 5M	122,55	121,41	107 - 5M	170,30	169,16	137 - 5M	218,04	216,90
18 - 5M	28,65	27,51	48 - 5M	76,39	75,25	78 - 5M	124,14	123,00	108 - 5M	171,89	170,75	138 - 5M	219,63	218,49
19 - 5M	30,24	29,10	49 - 5M	77,99	76,85	79 - 5M	125,73	124,59	109 - 5M	173,48	172,34	139 - 5M	221,23	220,09
20 - 5M	31,83	30,69	50 - 5M	79,58	78,44	80 - 5M	127,32	126,18	110 - 5M	175,07	173,93	140 - 5M	222,82	221,68
21 - 5M	33,42	32,28	51 - 5M	81,17	80,03	81 - 5M	128,92	127,78	111 - 5M	176,66	175,52	141 - 5M	224,41	223,27
22 - 5M	35,01	33,87	52 - 5M	82,76	81,62	82 - 5M	130,57	129,43	112 - 5M	178,25	177,11	142 - 5M	226,00	224,86
23 - 5M	36,61	35,47	53 - 5M	84,35	83,21	83 - 5M	132,10	130,96	113 - 5M	179,85	178,71	143 - 5M	227,59	226,45
24 - 5M	38,20	37,06	54 - 5M	85,94	84,80	84 - 5M	133,69	132,55	114 - 5M	181,44	180,30	144 - 5M	229,18	228,04
25 - 5M	39,79	38,65	55 - 5M	87,54	86,40	85 - 5M	135,28	134,14	115 - 5M	183,03	181,89	145 - 5M	230,77	229,63
26 - 5M	41,38	40,24	56 - 5M	89,13	87,99	86 - 5M	136,87	135,73	116 - 5M	184,62	183,48	146 - 5M	232,37	231,23
27 - 5M	42,97	41,83	57 - 5M	90,72	89,58	87 - 5M	138,46	137,32	117 - 5M	186,21	185,07	147 - 5M	233,96	232,82
28 - 5M	44,56	43,42	58 - 5M	92,31	91,17	88 - 5M	140,06	138,92	118 - 5M	187,80	186,66	148 - 5M	235,55	234,41
29 - 5M	46,15	45,01	59 - 5M	93,90	92,76	89 - 5M	141,65	140,51	119 - 5M	189,39	188,25	149 - 5M	237,14	236,00
30 - 5M	47,75	46,61	60 - 5M	95,49	94,35	90 - 5M	143,24	142,10	120 - 5M	190,99	189,85	150 - 5M	238,73	237,59
31 - 5M	49,34	48,20	61 - 5M	97,08	95,94	91 - 5M	144,83	143,69	121 - 5M	192,58	191,44	151 - 5M	240,32	239,18
32 - 5M	50,93	49,79	62 - 5M	98,68	97,54	92 - 5M	146,42	145,28	122 - 5M	194,17	193,03	152 - 5M	241,92	240,78
33 - 5M	52,52	51,38	63 - 5M	100,27	99,13	93 - 5M	148,01	146,87	123 - 5M	195,76	194,62	153 - 5M	243,51	242,37
34 - 5M	54,11	52,97	64 - 5M	101,86	100,72	94 - 5M	149,61	148,47	124 - 5M	197,35	196,21	154 - 5M	245,10	243,96
35 - 5M	55,70	54,56	65 - 5M	103,45	102,31	95 - 5M	151,20	150,06	125 - 5M	198,94	197,80	155 - 5M	246,69	245,55
36 - 5M	57,30	56,16	66 - 5M	105,04	103,90	96 - 5M	152,79	151,65	126 - 5M	200,54	199,40	156 - 5M	248,28	247,14
37 - 5M	58,89	57,75	67 - 5M	106,63	105,49	97 - 5M	154,38	153,24	127 - 5M	202,13	200,99	157 - 5M	249,87	248,73
38 - 5M	60,48	59,34	68 - 5M	108,23	107,09	98 - 5M	155,97	154,83	128 - 5M	203,72	202,58	158 - 5M	251,46	250,29
39 - 5M	62,07	60,93	69 - 5M	109,82	108,68	99 - 5M	157,56	156,42	129 - 5M	205,31	204,17	159 - 5M	253,06	251,92
40 - 5M	63,66	62,52	70 - 5M	111,46	110,27	100 - 5M	159,15	158,01	130 - 5M	206,90	205,76	160 - 5M	254,65	253,51
41 - 5M	65,25	64,11	71 - 5M	113,06	111,92	101 - 5M	160,75	159,61	131 - 5M	208,49	207,35			
42 - 5M	66,85	65,71	72 - 5M	114,59	113,45	102 - 5M	162,34	161,20	132 - 5M	210,08	208,94			

8 M (8 mm)

mm

Type Type Tipo	Ø pr.	Ø est.	Type Type Tipo	Ø pr.	Ø est.	Type Type Tipo	Ø pr.	Ø est.	Type Type Tipo	Ø pr.	Ø est.	Type Type Tipo	Ø pr.	Ø est.
18 - 8M	45,84	44,47	53 - 8M	134,96	133,59	89 - 8M	226,64	225,27	124 - 8M	315,76	314,39	160 - 8M	407,44	400,97
19 - 8M	48,38	47,01	54 - 8M	137,51	136,14	90 - 8M	229,18	227,81	125 - 8M	318,31	316,94	161 - 8M	409,98	408,61
20 - 8M	50,93	49,56	55 - 8M	140,06	138,68	91 - 8M	231,73	230,36	126 - 8M	320,86	319,49	162 - 8M	412,53	411,16
21 - 8M	53,48	52,11	56 - 8M	142,60	141,23	92 - 8M	234,28	232,90	127 - 8M	323,41	322,03	163 - 8M	415,08	413,70
22 - 8M	56,02	54,65	57 - 8M	145,15	143,78	93 - 8M	236,82	235,45	128 - 8M	325,95	324,58	164 - 8M	417,62	416,25
23 - 8M	58,57	57,20	58 - 8M	147,70	146,32	94 - 8M	239,37	238,00	129 - 8M	328,50	327,12	165 - 8M	420,17	418,80
24 - 8M	61,12	59,75	59 - 8M	150,24	148,87	95 - 8M	241,92	240,54	130 - 8M	331,04	329,67	166 - 8M	422,72	421,34
25 - 8M	63,66	62,29	60 - 8M	152,79	151,42	96 - 8M	244,46	243,09	131 - 8M	333,59	332,22	167 - 8M	425,26	423,89
26 - 8M	66,21	64,84	61 - 8M	155,34	153,96	97 - 8M	247,01	245,64	132 - 8M	336,14	334,76	168 - 8M	427,81	426,44
27 - 8M	68,75	67,38	62 - 8M	157,88	156,51	98 - 8M	249,55	248,18	133 - 8M	338,68	337,31	169 - 8M	430,25	428,98
28 - 8M	71,30	70,08	63 - 8M	160,43	159,06	99 - 8M	252,10	250,73	134 - 8M	341,23	339,86	170 - 8M	432,90	431,53
29 - 8M	73,85	72,62	64 - 8M	162,97	161,60	100 - 8M	254,65	253,28	135 - 8M	343,77	342,40	171 - 8M	435,45	434,08
30 - 8M	76,39	75,13	65 - 8M	165,52	164,15	101 - 8M	257,19	255,82	136 - 8M	346,32	344,95	172 - 8M	437,99	436,62
31 - 8M	78,94	77,68	66 - 8M	168,07	166,70	102 - 8M	259,74	258,37	137 - 8M	348,87	347,50	173 - 8M	440,54	439,17
32 - 8M	81,49	80,15	67 - 8M	170,61	169,24	103 - 8M	262,29	260,92	138 - 8M	351,41	350,04	174 - 8M	443,09	441,72
33 - 8M	84,03	82,68	68 - 8M	173,16	171,79	104 - 8M	264,83	263,46	139 - 8M	353,95	352,59	175 - 8M	445,63	444,26
34 - 8M	86,58	85,22	69 - 8M	175,71	174,34	105 - 8M	267,38	266,01	140 - 8M	356,51	355,14	176 - 8M	448,18	446,81
35 - 8M	89,13	87,76	70 - 8M	178,25	176,88	106 - 8M	269,93	268,56	141 - 8M	359,05	357,68	177 - 8M	450,73	449,36
36 - 8M	91,67	90,30	71 - 8M	180,80	179,43	107 - 8M	272,47	271,10	142 - 8M	361,60	360,23	178 - 8M	453,27	451,90
37 - 8M	94,22	92,85	72 - 8M	183,35	181,97	108 - 8M	275,02	273,65	143 - 8M	364,15	362,78	179 - 8M	455,82	454,45
38 - 8M	96,77	95,39	73 - 8M	185,89	184,52	109 - 8M	277,57	276,19	144 - 8M	366,69	365,32	180 - 8M	458,37	456,99
39 - 8M	99,31	97,94	74 - 8M	188,44	187,07	110 - 8M	280,11	278,74	145 - 8M	369,24	367,87	181 - 8M	460,91	459,54
40 - 8M	101,86	100,49	75 - 8M	190,99	189,61	111 - 8M	282,66	281,29	146 - 8M	371,79	370,42	182 - 8M	463,46	462,09
41 - 8M	104,41	103,03	76 - 8M	193,53	192,16	112 - 8M	285,21	283,83	147 - 8M	374,33	372,96	183 - 8M	466,01	464,63
42 - 8M	106,95	105,58	77 - 8M	196,08	194,71	113 - 8M	287,75	286,38	148 - 8M	376,88	375,51	184 - 8M	468,55	467,18
43 - 8M	109,50	108,13	78 - 8M	198,63	197,25	114 - 8M	290,30	288,93	149 - 8M	379,43	378,05	185 - 8M	471,10	469,73
44 - 8M	112,05	110,67	79 - 8M	201,17	199,81	115 - 8M	292,85	291,47	150 - 8M	381,97	380,60	186 - 8M	473,65	472,27
45 - 8M	114,59	113,22	80 - 8M	203,72	202,35	116 - 8M	295,39	294,02	151 - 8M	384,52	383,15	187 - 8M	476,19	474,82
46 - 8M	117,14	115,77	81 - 8M	206,26	204,89	117 - 8M	297,94	296,57	152 - 8M	387,06	385,70	188 - 8M	478,74	477,37
47 - 8M	119,68	118,31	82 - 8M	208,81	207,44	118 - 8M	300,48	299,11	153 - 8M	389,61	388,24	189 - 8M	481,28	479,91
48 - 8M	122,23	120,86	83 - 8M	211,36	209,99	119 - 8M	303,03	301,66	154 - 8M	392,16	390,79	190 - 8M	483,83	482,46
49 - 8M	124,78	123,41	84 - 8M	213,90	212,53	120 - 8M	305,58	304,21	155 - 8M	394,70	393,33	191 - 8M	486,38	485,01
50 - 8M	127,32	125,95	85 - 8M	216,45	215,08	121 - 8M	308,12	306,75	156 - 8M	397,25	395,88	192 - 8M	488,92	487,55
51 - 8M	129,87	128,50	86 - 8M	219,00	217,63	122 - 8M	310,67	309,30	157 - 8M	399,80	398,43			
52 - 8M	132,42	131,05	87 - 8M	221,54	220,17	123 - 8M	313,22	311,85	158 - 8M	402,34	400,97			
			88 - 8M	224,09	222,72				159 - 8M	404,89	403,52			

14 M (14 mm)

mm

Type Type Tipo	Ø pr.	Ø est.	Type Type Tipo	Ø pr.	Ø est.	Type Type Tipo	Ø pr.	Ø est.	Type Type Tipo	Ø pr.	Ø est.	Type Type Tipo	Ø pr.	Ø est.
28 - 14M	124,78	121,98	60 - 14M	267,38	264,59	93 - 14M	414,44	411,74	126 - 14M	561,50	558,70	159 - 14M	708,56	705,76
29 - 14M	129,33	126,44	61 - 14M	271,84	269,04	94 - 14M	418,90	416,10	127 - 14M	565,95	563,16	160 - 14M	713,01	710,22
30 - 14M	133,69	130,90	62 - 14M	276,29	273									

T 2,5 (2,5 mm)

Type Type Typ Tipo	∅ pr.	∅ est.
12 T2,5	9,55	9,00
14 T2,5	11,15	10,60
16 T2,5	11,94	11,40
18 T2,5	14,33	13,80
19 T2,5	15,13	14,60
20 T2,5	15,92	15,40
22 T2,5	17,55	17,00
24 T2,5	19,11	18,55
25 T2,5	19,90	19,35
26 T2,5	20,70	20,15
28 T2,5	22,30	21,75
30 T2,5	23,88	23,35
32 T2,5	25,48	24,95
36 T2,5	28,66	28,10
40 T2,5	31,85	31,30
44 T2,5	35,05	34,50
48 T2,5	38,22	37,70
60 T2,5	47,77	47,25

T 5 (5 mm)

Type Type Typ Tipo	∅ pr.	∅ est.
10 T5	15,92	15,05
12 T5	19,11	18,25
14 T5	22,29	21,25
15 T5	23,88	23,05
16 T5	25,48	24,60
18 T5	28,66	27,80
19 T5	30,25	29,40
20 T5	31,85	31,00
22 T5	35,12	34,25
24 T5	38,22	37,40
25 T5	39,81	39,00
26 T5	41,47	40,60
28 T5	44,62	43,75
30 T5	47,77	46,95
32 T5	50,95	50,10
36 T5	57,32	56,45
40 T5	63,69	62,85
42 T5	66,87	66,00
44 T5	70,07	69,20
48 T5	76,43	75,55
60 T5	95,54	94,65

T 10 (10 mm)

Type Type Typ Tipo	∅ pr.	∅ est.
12 T10	38,22	36,25
14 T10	44,58	42,70
15 T10	47,77	45,90
16 T10	50,95	49,05
18 T10	47,32	55,45
19 T10	60,51	58,60
20 T10	63,69	61,80
22 T10	70,12	68,15
24 T10	76,43	74,55
25 T10	79,62	77,70
26 T10	82,87	80,90
28 T10	89,22	87,25
30 T10	95,54	93,65
32 T10	101,91	100,00
36 T10	114,65	112,75
40 T10	127,39	125,45
44 T10	140,17	138,20
48 T10	152,87	150,95
60 T10	191,08	189,10

AT 5 (5 mm)

Type Type Typ Tipo	∅ pr.	∅ est.
12 AT5	19,10	17,85
14 AT5	22,29	21,05
15 AT5	23,88	22,65
16 AT5	25,47	24,20
18 AT5	28,65	27,40
19 AT5	30,25	29,00
20 AT5	31,83	30,60
22 AT5	35,02	33,85
24 AT5	38,21	37,00
25 AT5	39,80	38,60
26 AT5	41,39	40,20
27 AT5	42,98	41,80
28 AT5	44,58	43,35
30 AT5	47,76	46,55
32 AT5	50,94	49,70
36 AT5	57,31	56,05
40 AT5	63,66	62,45
42 AT5	66,86	65,60
44 AT5	70,05	68,80
48 AT5	76,42	75,15
60 AT5	95,52	94,25

AT 10 (10 mm)

Type Type Typ Tipo	∅ pr.	∅ est.
15 AT10	47,75	45,90
16 AT10	50,93	49,05
18 AT10	57,29	55,45
19 AT10	60,48	58,60
20 AT10	63,66	61,80
22 AT10	70,03	68,15
24 AT10	76,39	74,55
25 AT10	79,58	77,70
26 AT10	82,76	80,90
27 AT10	85,95	84,10
28 AT10	89,12	87,25
30 AT10	95,49	93,65
32 AT10	101,86	100,00
36 AT10	114,59	112,75
40 AT10	127,32	125,45
44 AT10	140,05	138,20
48 AT10	152,78	150,95
60 AT10	190,98	189,10

THERMOSETTING RESIN TIMING PULLEYS, TYPE «PP»
POULIES DENTEES EN MATERIE PLASTIQUE THERMODURCISSABLE, TYPE «PP»
KUNSTHARZ-ZAHNSCHEIBEN TYP «PP»
POLEAS DENTADAS EN RESINA TERMOENDURENTE, TIPO «PP»

Characteristics

- The toothed side is drop-moulded from thermosetting resins of high dimensional stability and reinforced with high resistance textile fibres.
- The hub is metallic, to give greater strength and better resistance for the keyway and thread. As regards the «XL» pulleys, the hub is generally in extruded light alloy of great hardness; as regards the «L» pulleys, the hub is in steel.
- An excellent precision has been obtained by absolutely original pressure-moulding system.
- The cost is considerably lower in comparison with the fully metallic pulleys.
- They are remarkably light and show an excellent tooth wear resistance.
- Specials can be manufactured to clients drawings if the quantities are sufficient.

Assembling

It is common knowledge that, in any transmission, the toothed belt has to be retained by at least two opposed flanges. As the plastic pulleys have one only flange, their construction has also been foreseen in the two «FF» an «FM» types, so as to meet the above mentioned condition more easily.

Nomenclature

To completely define a thermosetting resin timing pulley, its normal denomination has to be preceded by the letters PP and followed by the letters FF to specify a flange on the side opposite the boss or the letters FM for a flange on the side of the boss. EG: PP 10 L 050 FF is a 10 teeth thermosetting resin pulley of «L» pitch, for a 1/2" wide belt with a flange on the side opposite to the boss. A PP 10 L 050 is the same pulley with a flange on the side of the boss.

Características

- Les poulies dentées sont moulées en matière plastique thermosurable a grande stabilité dimensionnelle, renforcée par des fibres textiles à haute résistance.
- Les moyeux sont métalliques, afin d'offrir une résistance suffisante aux rainures de clavettes et aux vis de blocage éventuelle. En principe, les moyeux sont en alliage léger extrudé de grande dureté pour les poulies type «XL» et en acier pour les poulies type «L».
- Une grande précision a été obtenue par le principe de moulage absolument original.
- La série des poulies «plastiques» es très économique par rapport aux poulies métalliques.
- Elles sont très légères, malgré une grande résistance a l'usure de la denture.
- Pour des applications par quantités, il est possible de réaliser des poulies «plastiques» spéciales sur plan.

Montage

Dans toutes les transmissions positives, la courroie dentée doit être maintenue sur les poulies par 2 flasques opposés. Dans le cas des poulies «plastiques», un seul flasque est prévu sur chaque poulie; néanmoins, les exécutions FF et FM permettent de satisfaire à ces exigences.

Nomenclature

Pour définir une poulie dentée en matière plastique thermosurable, on fera précéder à la dénomination classique les lettres PP; en outre, cette dénomination sera suivie par les lettres FF ou FM, suivant que la flasque se trouve du côté du moyeu débordant ou à l'opposé. EX.: PP 10 L 050 FF sera une poulie de 10 dents, pas 3/8", adaptée pour une courroie de largeur 1/2", avec flasque opposé au moyeu débordant. PP 10 L 050 FM sera la même poulie, avec flasque du côté du moyeu débordant.

Eigenschaften

- Das verzahnte Teil wird aus härtbarem Kunstharz zu großer Maßbeständigkeit gepresst und mit Textilfasern hohen Widerstandes armiert.
- Die Nabe ist metallisch, damit ein hoher Widerstand bei dem Faßfedernut und eventuell angebrachten Gewindebohrungen gewährleistet wird. Normalweise besteht die Nabe bei den «XL»-Zahnscheiben aus fließgepresstem Leichtmetall großer Härte und bei den «L»-Zahnscheiben aus Stahl.
- Eine hohe Präzision wurde durch absolut neuartige Pressverfahren gewonnen.
- Die Kosten sind beträchtlich niedriger als für metallische Zahnscheiben.
- Hohe Verschleißfestigkeit wird bei geringstem Gewicht erreicht. Für hohe Stückzahlen können Sonder-Ausführungen nach Zeichnung de Kunden gefertigt werden.

Montage

Bekanntlich muß der Zahnriemen bei jedem Antrieb von mindestens zwei gekreuzt gegenüberliegenden Borden geführt werden. Da die Kunstharz-Zahnscheiben nur einen Bord haben, wurde die entsprechende Konstruktion nach den zwei «FF» und «FM»-Ausführungen vorgesehen, damit die oben erwähnte Forderung erreicht wird.

Nomenklatur

Zur Bestimmung einer Kunstharz-Zahnscheibe wird generell die Abkürzung «PP» an den Anfang gesetzt. Ist der Bord an der bündigen Seite angebracht wird die Abkürzung FF an das Ende der Gesamtbezeichnung gesetzt. Ist der Bord an der Nabenseite angebracht endet die Bezeichnung mit «FM». Beispiel: PP 10 L 050 FF ist eine Kunstharz-Zahnscheibe mit 10 Zähnen, «L» Teilung und einseitigem Bord an der bündigen Seite. Die Scheibe ist für einen 1/2" Riemen geeignet. PP 10 L 050 FM bezeichnet die gleiche Zahnscheibe jedoch als einteilige Bordscheibe mit nabenseitigem Bord.

Características

- La parte dentada está estampada en resina termoendurente de gran estabilidad dimensional y armada con fibra textil de alta resistencia.
- El núcleo es metálico a fin de garantizar la máxima resistencia con la correspondiente chaveta o de las eventuales ranuras. Normalmente el núcleo es de aleación ligera de gran dureza para las poleas «XL», y en acero para las poleas tipo «L».
- Hemos obtenido una excelente precisión con nuestro sistema de estampación.
- El costo es notablemente inferior respecto a la polea completamente metálica.
- Reunimos dos condiciones: – gran ligereza – óptima resistencia al desgaste del diente.
- Para grandes cantidades es posible fabricar ejecuciones especiales bajo plano.

Montaje

En cada transmisión la correa dentada debe ser guiada al menos por dos valonas contrapuestas. Dado que las poleas dentadas en plástico tienen una sola valona, ha estado previsto la construcción según las dos ejecuciones «FF» y «FM» de manera que podamos satisfacer esta condición.

Nomenclatura

Para definir completamente una polea dentada en resina termoendurente se hará preceder a la denominación normal las letras «PP» e indicando «FF» si la valona se encuentra en el lado donde el núcleo está a filo o «FM» si la valona está en el lado que el núcleo sobresale. Ejemplo: PP 10 L 050 FF será una polea en resina termoendurente de 10 dientes, paso L, adaptada para una correa de ancho 1/2" con valona al lado del núcleo a filo con el dentado, mientras PP 10 L 050 FM será la misma polea con la valona en el lado donde el núcleo sobresale.

PP ... XL 037

mm

code code Code código	flange flasque Bord valona	type type Typ tipo	R Ø	S Ø	U Ø	E Ø	L	F	W	H Ø	Y	Z
PP 11 XL 037	FM FF	1	17,79	17,28	-	20,5	11	2	13	12,5	21	8
PP 12 XL 037	FM FF	1	19,40	18,89	-	22	11	2	13	12,5	21	8
PP 14 XL 037	FM FF	1	22,64	22,13	-	25,5	11	2	13	16	21	8
PP 15 XL 037	FM FF	1	24,25	23,74	-	27	11	2	13	18	25	12
PP 16 XL 037	FM FF	1	25,87	25,36	-	28,5	11	2	13	18	25	12
PP 18 XL 037	FM FF	1	29,11	28,60	-	32	11	2	13	20	25	12
PP 20 XL 037	FM FF	1	32,34	31,83	-	35	11	2	13	20	25	12
PP 21 XL 037	FM FF	1	33,96	33,45	-	36,5	11	2	13	20	25	12
PP 22 XL 037	FM FF	1	35,57	35,06	-	38,5	11	2	13	20	25	12
PP 24 XL 037	FM FF	1	38,81	38,30	-	41,5	11	2,5	13,5	25	25	11,5
PP 28 XL 037	FM FF	1	45,28	44,77	-	48	11	2,5	13,5	25	25	11,5
PP 30 XL 037	FM FF	2	48,65	48,00	40	51	11	2,5	13,5	25	25	11,5
PP 32 XL 037	FM FF	2	51,74	51,23	42	54,5	11	2,5	13,5	25	25	11,5
PP 36 XL 037	FM FF	2	58,21	57,70	49	61	11	2,5	13,5	35	25	11,5
PP 40 XL 037	FM FF	2	64,68	64,17	54	67,5	11	2,5	13,5	35	25	11,5
PP 42 XL 037	FM FF	2	67,91	67,40	57	70,5	11	2,5	13,5	35	25	11,5
PP 44 XL 037	FM FF	2	71,15	70,64	60	74	11	2,5	13,5	35	25	11,5
PP 48 XL 037	FM FF	2	77,62	77,11	68	80,5	11	2,5	13,5	35	25	11,5
PP 50 XL 037	FM FF	2	80,85	80,34	71	83	11	2,5	13,5	35	25	11,5

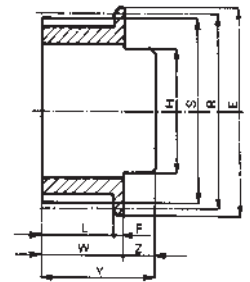

PP ... L 050

mm

code code Code código	flange flasque Bord valona	type type Typ tipo	R Ø	S Ø	U Ø	E Ø	L	F	W	H Ø	Y	Z
PP 10 L 050	FM FF	1	30,32	29,56	-	34	14,5	2	16,5	20	25	8,5
PP 12 L 050	FM FF	1	36,38	35,62	-	40	14,5	2	16,5	25	25	8,5
PP 14 L 050	FM FF	1	42,45	41,69	-	46	14,5	2,5	17	30	30	13
PP 16 L 050	FM FF	1	48,51	47,75	-	52	14,5	2,5	17	30	30	13
PP 18 L 050	FM FF	2	54,57	53,81	43	58	14,5	2,5	17	30	30	13
PP 20 L 050	FM FF	2	60,64	59,88	48	64	14,5	2,5	17	30	30	13
PP 22 L 050	FM FF	2	66,70	65,94	56	70	14,5	2,5	17	40	30	13
PP 24 L 050	FM FF	2	72,77	72,01	60	76	14,5	2,5	17	40	30	13
PP 26 L 050	FM FF	2	78,83	78,07	65	82,5	14,5	2,5	17	40	30	13
PP 28 L 050	FM FF	2	84,89	84,13	71	88,5	14,5	2,5	17	40	30	13
PP 30 L 050	FM FF	2	90,96	90,20	76	94,5	14,5	2,5	17	40	30	13
PP 32 L 050	FM FF	2	97,02	96,26	85	100,5	14,5	2,5	17	40	30	13
PP 36 L 050	FM FF	2	109,15	108,39	94	112,5	14,5	2,5	17	50	40	23
PP 40 L 050	FM FF	2	121,28	120,52	102	125	14,5	2,5	17	50	40	23

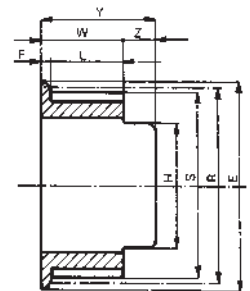

1

PP ... L 100

mm

code code Code código	flange flasque Bord valona	type type Typ tipo	R Ø	S Ø	U Ø	E Ø	L	F	W	H Ø	Y	Z
PP 10 L 100	FM FF	1	30,32	29,56	-	34	27,5	2	29,5	20	40	10,5
PP 12 L 100	FM FF	1	36,38	35,62	-	40	27,5	2	29,5	25	40	10,5
PP 14 L 100	FM FF	1	42,45	41,69	-	46	27,5	2,5	30	30	40	10
PP 16 L 100	FM FF	1	48,51	47,75	-	52	27,5	2,5	30	30	40	10
PP 18 L 100	FM FF	1	54,57	53,81	-	58	27,5	2,5	30	40	50	20
PP 20 L 100	FM FF	1	60,64	59,88	-	64	27,5	2,5	30	40	50	20
PP 22 L 100	FM FF	2	66,70	65,94	55	70	27,5	2,5	30	40	50	20
PP 24 L 100	FM FF	2	72,77	72,01	59	76	27,5	2,5	30	40	50	20
PP 26 L 100	FM FF	2	78,83	78,07	64	82,5	27,5	2,5	30	40	50	20
PP 28 L 100	FM FF	2	84,89	84,13	71	88,5	27,5	2,5	30	48	50	20
PP 30 L 100	FM FF	2	90,96	90,20	76	94,5	27,5	2,5	30	48	50	20
PP 32 L 100	FM FF	2	97,02	96,26	85	100,5	27,5	2,5	30	48	50	20
PP 36 L 100	FM FF	2	109,15	108,39	92	112,5	27,5	2,5	30	57	50	20
PP 40 L 100	FM FF	2	121,28	120,52	102	125	27,5	2,5	30	57	50	20

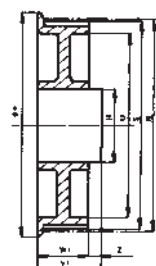
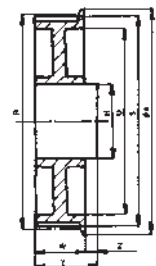

2

Material of hubs:
- Aluminium (pulleys XL 037 and L 050)
- Steel (pulleys L 100)

Materiel du moyeu:
- Aluminium (poules XL 037 et L 050)
- Acier (poules L 100)

Werkstoff der nabe:
- Aluminium für XL 037 und L 050
- Stahl für L 100 Zahnscheiben

Material del núcleo:
- Aluminio (poleas XL 037 y L 050)
- Acero (poleas L 100)

STANDARD METALLIC TIMING PULLEYS
POULIES DENTEES METALLIQUES DE SERIE
STANDARD-METALL-ZAHNSCHEIBEN
POLEAS DENTADAS DE SERIE METALICA

PD ... XL 037

mm

code code Code código	type type Typ tipo	teeth dents Zähne dientes	R Ø	S Ø	U Ø	e Ø	W	H Ø	Y	Z	d Ø	flange flasque Bord valona	material materiel Werkstoff material
PD 10 XL 037	1	10	16,17	15,66	-	20	14,3	12	25	10,7	-	with flanges avec flasques mit Borde con valona	Aluminium - Aluminium - Aluminio
PD 11 XL 037	1	11	17,79	17,28	-	20	14,3	12	25	10,7	-		
PD 12 XL 037	1	12	19,40	18,89	-	24	14,3	12	25	10,7	-		
PD 13 XL 037	1	13	21,02	20,51	-	24	14,3	12	25	10,7	-		
PD 14 XL 037	1	14	22,64	22,16	-	27	14,3	16	25	10,7	-		
PD 15 XL 037	1	15	24,25	23,74	-	27	14,3	17	25	10,7	-		
PD 16 XL 037	1	16	25,87	25,36	-	30	14,3	20	25	10,7	-		
PD 17 XL 037	1	17	27,49	26,98	-	30	14,3	20	25	10,7	-		
PD 18 XL 037	1	18	29,11	28,60	-	33	14,3	20	25	10,7	-		
PD 19 XL 037	1	19	30,72	30,21	-	36	14,3	25	25	10,7	-		
PD 20 XL 037	1	20	32,34	31,83	-	36	14,3	25	25	10,7	-		
PD 21 XL 037	1	21	33,96	33,45	-	40	14,3	26	25	10,7	-		
PD 22 XL 037	1	22	35,57	35,06	-	40	14,3	27	25	10,7	-		
PD 24 XL 037	1	24	38,81	38,30	-	46	14,3	30	25	10,7	-		
PD 26 XL 037	1	26	42,03	41,53	-	46	14,3	30	25	10,7	-		
PD 27 XL 037	1	27	43,66	43,15	-	50	14,3	32	25	10,7	-		
PD 28 XL 037	1	28	45,28	44,77	-	50	14,3	34	25	10,7	-		
PD 29 XL 037	1	29	46,89	46,38	-	50	14,3	34	25	10,7	-		
PD 30 XL 037	1	30	49,51	48,00	-	55	14,3	38	25	10,7	-		
PD 32 XL 037	1	32	51,74	51,23	-	-	14,3	45	25	10,7	-		
PD 34 XL 037	1	34	54,98	54,47	-	-	14,3	45	25	10,7	-		
PD 35 XL 037	1	35	56,60	56,09	-	-	14,3	45	25	10,7	-		
PD 36 XL 037	1	36	58,21	57,70	-	-	14,3	52	25	10,7	-		
PD 38 XL 037	1	38	61,45	60,94	-	-	14,3	52	25	10,7	-		
PD 39 XL 037	1	39	63,06	62,55	-	-	14,3	52	25	10,7	-		
PD 40 XL 037	1	40	64,68	64,17	-	-	14,3	52	25	10,7	-		
PD 41 XL 037	1	41	66,30	65,79	-	-	14,3	52	25	10,7	-		
PD 42 XL 037	1	42	67,91	67,40	-	-	14,3	52	25	10,7	-		
PD 43 XL 037	1	43	69,53	69,02	-	-	14,3	52	25	10,7	-		
PD 44 XL 037	1	44	71,15	70,64	-	-	14,3	52	25	10,7	-		
PD 45 XL 037	1	45	72,77	72,26	-	-	14,3	52	25	10,7	-		
PD 46 XL 037	1	46	74,38	73,87	-	-	14,3	52	25	10,7	-		
PD 47 XL 037	1	47	76,00	75,49	-	-	14,3	52	25	10,7	-		
PD 48 XL 037	1	48	77,62	77,11	-	-	14,3	52	25	10,7	-		
PD 49 XL 037	2	49	79,23	78,72	54	-	14,3	52	25	10,7	-		
PD 52 XL 037	2	52	84,08	83,57	58	-	14,3	52	25	10,7	-		
PD 56 XL 037	2	56	90,55	90,04	65	-	14,3	52	25	10,7	-		
PD 57 XL 037	2	57	92,17	91,66	67	-	14,3	52	25	10,7	-		
PD 58 XL 037	2	58	93,79	93,28	69	-	14,3	52	25	10,7	-		
PD 59 XL 037	2	59	95,40	94,89	70	-	14,3	52	25	10,7	-		
PD 60 XL 037	2	60	97,02	96,51	71	-	14,3	52	25	10,7	-		
PD 68 XL 037	2	68	109,96	109,45	84	-	14,3	52	25	10,7	-		
PD 69 XL 037	2	69	111,57	111,06	86	-	14,3	52	25	10,7	-		
PD 70 XL 037	2	70	113,19	112,68	87	-	14,3	52	25	10,7	-		
PD 71 XL 037	2	71	114,81	114,30	89	-	14,3	52	25	10,7	-		
PD 72 XL 037	2	72	116,43	115,92	91	-	14,3	52	25	10,7	-		

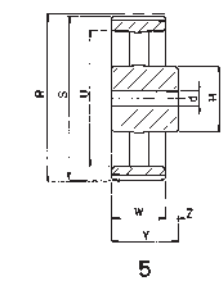
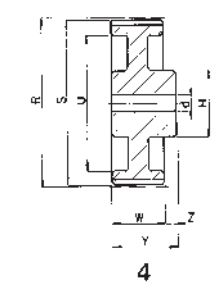
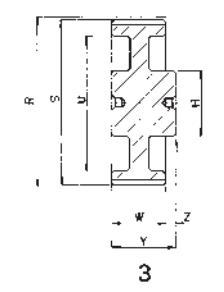
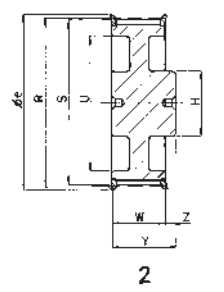
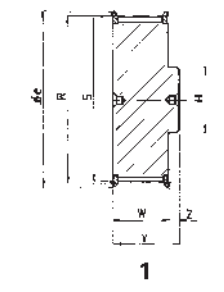

PD ... L 050

mm

code code Code código	type type Typ tipo	teeth dents Zähne dientes	R Ø	S Ø	U Ø	e Ø	W	H Ø	Y	Z	d Ø	flange flasque Bord valona	material materiel Werkstoff material
PD 10 L 050	1	10	30,32	29,56	-	33	19	20	30	11	-	with flanges avec flasques mit Borde con valona	steel acier Stahl acero
PD 11 L 050	1	11	33,35	32,59	-	36	19	20	30	11	-		
PD 12 L 050	1	12	36,38	35,62	-	40	19	27	30	11	-		
PD 13 L 050	1	13	39,41	38,65	-	47	19	27	30	11	-		
PD 14 L 050	1	14	42,45	41,69	-	46	19	29	30	11	-		
PD 15 L 050	1	15	45,48	44,72	-	50	19	32	30	11	-		
PD 16 L 050	1	16	48,51	47,75	-	55	19	37	30	11	-		
PD 17 L 050	1	17	51,54	50,78	-	55	19	37	30	11	-		
PD 18 L 050	1	18	54,57	53,81	-	62	19	41	30	11	-		
PD 19 L 050	1	19	57,61	56,84	-	62	19	41	30	11	-		
PD 20 L 050	1	20	60,64	59,88	-	67	19	47	30	11	-		
PD 21 L 050	1	21	63,67	62,91	-	67	19	47	30	11	-		
PD 22 L 050	1	22	66,70	65,94	-	73	19	50	30	11	-		
PD 23 L 050	1	24	69,73	68,97	-	73	19	50	30	11	-		
PD 24 L 050	1	26	72,77	72,01	-	80	19	57	32	13	-		
PD 25 L 050	1	25	75,80	75,04	-	80	19	58	32	13	-		
PD 26 L 050	1	26	78,83	78,07	-	88	19	64	32	13	-		
PD 27 L 050	1	27	81,86	81,10	-	88	19	64	32	13	-		
PD 28 L 050	1	28	84,89	84,13	-	94	19	70	32	13	-		
PD 29 L 050	1	29	87,93	87,16	-	94	19	70	32	13	-		
PD 30 L 050	1	30	90,96	90,20	-	98	19	72	34	15	-		
PD 32 L 050	1	32	97,02	96,26	-	100	19	75	34	15	-		
PD 33 L 050	1	33	100,05	99,29	-	108	19	80	34	15	-		
PD 34 L 050	1	34	103,08	102,32	-	108	19	85	34	15	-		
PD 35 L 050	1	35	106,12	105,35	-	113	19	88	34	15	-		
PD 36 L 050	1	36	109,15	108,39	-	113	19	88	34	15	-		
PD 40 L 050	2	40	121,28	120,52	100	129	19	68	34	15	-		
PD 41 L 050	2	41	124,31	123,55	103	129	19	68	34	15	-		
PD 42 L 050	2	42	127,34	126,58	106	137	19	68	34	15	-		
PD 44 L 050	2	44	133,40	132,64	112	142	19	68	34	15	-		
PD 45 L 050	2	45	136,44	135,67	115	142	19	68	34	15	-		
PD 47 L 050	2	47	142,50	141,74	121	149	19	68	34	15	-		
PD 48 L 050	2	48	145,53	144,77	124	151	19	68	46	27	-		
PD 49 L 050	3	49	148,56	147,80	127	-	19	68	46	27	-		
PD 50 L 050	3	50	151,60	150,83	130	-	19	68	46	27	-		
PD 52 L 050	3	52	157,66	156,90	136	-	19	68	46	27	-		
PD 56 L 050	3	56	169,79	169,02	139	-	19	68	46	27	-		
PD 57 L 050	3	57	172,82	172,06	152	-	19	68	46	27	-		
PD 60 L 050	3	60	181,91	181,15	160	-	19	68	46	27	-		
PD 65 L 050	3	65	197,07	196,31	176	-	19	68	46	27	-		
PD 66 L 050	3	66	200,11	199,34	179	-	19	68	46	27	-		
PD 72 L 050	3	72	218,30	217,54	197	-	19	75	46	27	-		
PD 84 L 050	3	84	254,68	253,92	233	-	19	75	46	27	-		
PD 90 L 050	4	90	272,87	272,11	252	-	19	75	46	27	19		
PD 96 L 050	4	96	291,06	290,30	270	-	19	80	46	27	19		
PD 120 L 050	5	120	363,83	363,07	342	-	19	85	46	27	19		



PD ... L 075

mm

code code Code Código	type type Typ tipo	teeth dents Zähne dientes	R Ø	S Ø	U Ø	e Ø	W	H Ø	Y	Z	d Ø	flange flasque Bord valona	material materiel Werkstoff material
PD 10 L 075	1	10	30,32	29,56	-	33	25,4	20	38	12,6	-	with flanges avec flasques mit Borde con valona	steel acier Stahl acero
PD 11 L 075	1	11	33,35	32,59	-	36	25,4	20	38	12,6	-		
PD 12 L 075	1	12	36,38	35,62	-	40	25,4	27	38	12,6	-		
PD 13 L 075	1	13	39,41	38,65	-	47	25,4	27	38	12,6	-		
PD 14 L 075	1	14	42,45	41,69	-	46	25,4	29	38	12,6	-		
PD 15 L 075	1	15	45,48	44,72	-	50	25,4	32	38	12,6	-		
PD 16 L 075	1	16	48,51	47,75	-	55	25,4	37	38	12,6	-		
PD 17 L 075	1	17	51,54	50,78	-	55	25,4	37	38	12,6	-		
PD 18 L 075	1	18	54,57	53,81	-	62	25,4	41	38	12,6	-		
PD 19 L 075	1	19	57,61	56,84	-	62	25,4	41	38	12,6	-		
PD 20 L 075	1	20	60,64	59,88	-	67	25,4	47	38	12,6	-		
PD 21 L 075	1	21	63,67	62,91	-	67	25,4	47	38	12,6	-		
PD 22 L 075	1	22	66,70	65,94	-	73	25,4	50	38	12,6	-		
PD 23 L 075	1	24	69,73	68,97	-	73	25,4	50	30	12,6	-		
PD 24 L 075	1	26	72,77	72,01	-	80	25,4	57	38	12,6	-		
PD 25 L 075	1	25	75,80	75,04	-	80	25,4	58	38	12,6	-		
PD 26 L 075	1	26	78,83	78,07	-	88	25,4	64	38	12,6	-		
PD 27 L 075	1	27	81,86	81,10	-	88	25,4	64	38	12,6	-		
PD 28 L 075	1	28	84,89	84,13	-	94	25,4	70	38	12,6	-		
PD 29 L 075	1	29	87,93	87,16	-	94	25,4	70	38	12,6	-		
PD 30 L 075	1	30	90,96	90,20	-	98	25,4	72	38	12,6	-		
PD 32 L 075	1	32	97,02	96,26	-	100	25,4	75	38	12,6	-		
PD 33 L 075	1	33	100,05	99,29	-	108	25,4	80	38	12,6	-		
PD 34 L 075	1	34	103,08	102,32	-	108	25,4	85	38	12,6	-		
PD 35 L 075	1	35	106,12	105,35	-	113	25,4	88	38	12,6	-		
PD 36 L 075	1	36	109,15	108,39	-	113	25,4	88	38	12,6	-		
PD 40 L 075	2	40	121,28	120,52	100	129	25,4	68	38	12,6	-		
PD 41 L 075	2	41	124,31	123,55	103	129	25,4	68	38	12,6	-		
PD 42 L 075	2	42	127,34	126,58	106	137	25,4	68	38	12,6	-		
PD 44 L 075	2	44	133,40	132,64	112	142	25,4	68	38	12,6	-		
PD 45 L 075	2	45	136,44	135,67	115	142	25,4	68	38	12,6	-		
PD 47 L 075	2	47	142,50	141,74	121	149	25,4	68	38	12,6	-		
PD 48 L 075	2	48	145,53	144,77	124	151	25,4	68	48	22,6	-		
PD 49 L 075	3	49	148,56	147,80	127	-	25,4	68	48	22,6	-		
PD 50 L 075	3	50	151,60	150,83	130	-	25,4	68	48	22,6	-		
PD 52 L 075	3	52	157,66	156,90	136	-	25,4	68	48	22,6	-		
PD 56 L 075	3	56	169,79	169,02	139	-	25,4	68	48	22,6	-		
PD 57 L 075	3	57	172,82	172,06	152	-	25,4	68	48	22,6	-		
PD 60 L 075	3	60	181,91	181,15	160	-	25,4	68	48	22,6	-		
PD 65 L 075	3	65	197,07	196,31	176	-	25,4	68	48	22,6	-		
PD 66 L 075	3	66	200,11	199,34	179	-	25,4	68	48	22,6	-		
PD 72 L 075	3	72	218,30	217,54	197	-	25,4	75	48	22,6	-		
PD 84 L 075	3	84	254,68	253,92	233	-	25,4	75	48	22,6	-		
PD 90 L 075	4	90	272,87	272,11	252	-	25,4	75	48	22,6	19		
PD 96 L 075	4	96	291,06	290,30	270	-	25,4	80	48	22,6	19		
PD 120 L 075	5	120	363,83	363,07	342	-	25,4	85	48	22,6	19		

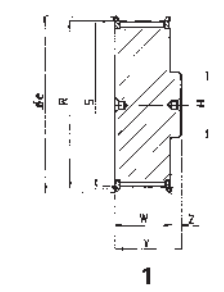

1

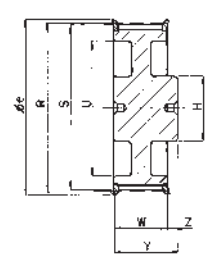

2

PD ... L 100

mm

code code Code Código	type type Typ tipo	teeth dents Zähne dientes	R Ø	S Ø	U Ø	e Ø	W	H Ø	Y	Z	d Ø	flange flasque Bord valona	material materiel Werkstoff material
PD 10 L 100	1	10	30,32	29,56	-	33	32	20	46	14	-	with flanges avec flasques mit Borde con valona	steel acier Stahl acero
PD 11 L 100	1	11	33,35	32,59	-	36	32	20	46	14	-		
PD 12 L 100	1	12	36,38	35,62	-	40	32	27	46	14	-		
PD 13 L 100	1	13	39,41	38,65	-	47	32	27	46	14	-		
PD 14 L 100	1	14	42,45	41,69	-	46	32	29	46	14	-		
PD 15 L 100	1	15	45,48	44,72	-	50	32	32	46	14	-		
PD 16 L 100	1	16	48,51	47,75	-	55	32	37	46	14	-		
PD 17 L 100	1	17	51,54	50,78	-	55	32	37	46	14	-		
PD 18 L 100	1	18	54,57	53,81	-	62	32	41	46	14	-		
PD 19 L 100	1	19	57,61	56,84	-	62	32	41	46	14	-		
PD 20 L 100	1	20	60,64	59,88	-	67	32	47	46	14	-		
PD 21 L 100	1	21	63,67	62,91	-	67	32	47	46	14	-		
PD 22 L 100	1	22	66,70	65,94	-	73	32	50	46	14	-		
PD 23 L 100	1	24	69,73	68,97	-	73	32	50	46	14	-		
PD 24 L 100	1	26	72,77	72,01	-	80	32	57	46	14	-		
PD 25 L 100	1	25	75,80	75,04	-	80	32	58	46	14	-		
PD 26 L 100	1	26	78,83	78,07	-	88	32	64	46	14	-		
PD 27 L 100	1	27	81,86	81,10	-	88	32	64	46	14	-		
PD 28 L 100	1	28	84,89	84,13	-	94	32	70	46	14	-		
PD 29 L 100	1	29	87,93	87,16	-	94	32	70	46	14	-		
PD 30 L 100	1	30	90,96	90,20	-	98	32	72	46	14	-		
PD 32 L 100	1	32	97,02	96,26	-	100	32	75	46	14	-		
PD 33 L 100	1	33	100,05	99,29	-	108	32	80	46	14	-		
PD 34 L 100	1	34	103,08	102,32	-	108	32	85	46	14	-		
PD 35 L 100	1	35	106,12	105,35	-	113	32	88	46	14	-		
PD 36 L 100	1	36	109,15	108,39	-	113	32	88	46	14	-		
PD 40 L 100	2	40	121,28	120,52	100	129	32	68	46	14	-		
PD 41 L 100	2	41	124,31	123,55	103	129	32	68	46	14	-		
PD 42 L 100	2	42	127,34	126,58	106	137	32	68	46	14	-		
PD 44 L 100	2	44	133,40	132,64	112	142	32	68	46	14	-		
PD 45 L 100	2	45	136,44	135,67	115	142	32	68	46	14	-		
PD 47 L 100	2	47	142,50	141,74	121	149	32	68	46	14	-		
PD 48 L 100	2	48	145,53	144,77	124	151	32	68	50	18	-		
PD 49 L 100	3	49	148,56	147,80	127	-	32	68	50	18	-		
PD 50 L 100	3	50	151,60	150,83	130	-	32	68	50	18	-		
PD 52 L 100	3	52	157,66	156,90	136	-	32	68	50	18	-		
PD 56 L 100	3	56	169,79	169,02	139	-	32	68	50	18	-		
PD 57 L 100	3	57	172,82	172,06	152	-	32	68	50	18	-		
PD 60 L 100	3	60	181,91	181,15	160	-	32	75	54	22	-		
PD 65 L 100	3	65	197,07	196,31	176	-	32	75	54	22	-		
PD 66 L 100	3	66	200,11	199,34	179	-	32	75	54	22	-		
PD 72 L 100	3	72	218,30	217,54	197	-	32	75	54	22	-		
PD 84 L 100	3	84	254,68	253,92	233	-	32	80	54	22	-		
PD 90 L 100	4	90	272,87	272,11	252	-	32	80	54	22	19		
PD 96 L 100	4	96	291,06	290,30	270	-	32	80	54	22	19		
PD 120 L 100	5	120	363,83	363,07	342	-	32	90	54	22	19		

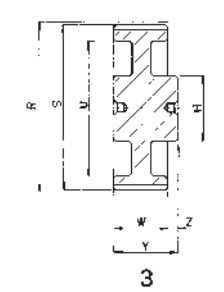

3

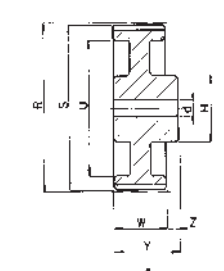

4

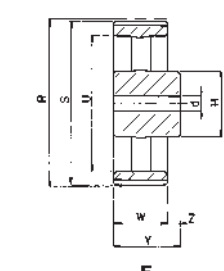

5

PD ... H 075

mm

code Code Code código	type type Typ tipo	teeth dents Zähne dientes	R Ø	S Ø	U Ø	e Ø	W	H Ø	Y	Z	d Ø	flange flasque Bord valona	material materiel Werkstoff material
PD 14 H 075	1	14	56,60	55,23	-	62	25,4	40	38	12,6	-	with flanges avec flasques mit Borde con valona	steel acier Stahl acero
PD 15 H 075	1	15	60,64	59,27	-	67	25,4	45	38	12,6	-		
PD 16 H 075	1	16	64,68	63,31	-	67	25,4	47	38	12,6	-		
PD 17 H 075	1	17	68,72	67,35	-	77	25,4	49	38	12,6	-		
PD 18 H 075	1	18	72,77	71,40	-	80	25,4	57	38	12,6	-		
PD 19 H 075	1	19	76,81	75,44	-	84	25,4	60	38	12,6	-		
PD 20 H 075	1	20	80,85	79,48	-	88	25,4	64	38	12,6	-		
PD 21 H 075	1	21	84,89	83,52	-	94	25,4	64	38	12,6	-		
PD 22 H 075	1	22	88,94	87,57	-	94	25,4	70	38	12,6	-		
PD 23 H 075	1	23	92,98	91,61	-	98	25,4	72	38	12,6	-		
PD 24 H 075	1	24	97,02	95,65	-	104	25,4	80	38	12,6	-		
PD 25 H 075	1	25	101,06	99,69	-	104	25,4	80	38	12,6	-		
PD 26 H 075	1	26	105,11	103,74	-	108	25,4	85	38	12,6	-		
PD 27 H 075	1	27	109,15	107,78	-	113	25,4	88	38	12,6	-		
PD 28 H 075	1	28	113,19	111,92	-	118	25,4	94	38	12,6	-		
PD 29 H 075	1	29	117,23	115,86	-	121	25,4	96	38	12,6	-		
PD 30 H 075	1	30	121,28	119,91	-	129	25,4	104	38	12,6	-		
PD 32 H 075	1	32	129,36	127,99	-	137	25,4	112	38	12,6	-		
PD 33 H 075	1	33	133,40	132,03	-	137	25,4	112	38	12,6	-		
PD 34 H 075	1	34	137,45	136,08	-	142	25,4	118	38	12,6	-		
PD 35 H 075	2	35	141,49	140,12	118	145	25,4	68	48	22,6	-		
PD 36 H 075	2	36	145,53	144,16	118	151	25,4	68	48	22,6	-		
PD 38 H 075	2	38	153,62	152,25	126	158	25,4	68	48	22,6	-		
PD 40 H 075	2	40	161,70	160,33	134	168	25,4	68	48	22,6	-		
PD 44 H 075	2	44	177,87	176,50	150	191	25,4	68	48	22,6	-		
PD 45 H 075	2	45	181,91	180,54	154	189	25,4	68	48	22,6	-		
PD 48 H 075	2	48	194,04	192,67	166	199	25,4	68	48	22,6	-		
PD 49 H 075	3	49	198,08	196,71	170	-	25,4	68	48	22,6	-		
PD 50 H 075	3	50	202,13	200,76	174	-	25,4	68	48	22,6	-		
PD 52 H 075	3	52	210,21	208,84	182	-	25,4	75	48	22,6	-		
PD 60 H 075	3	60	242,55	241,18	215	-	25,4	75	48	22,6	-		
PD 70 H 075	3	70	282,98	281,61	255	-	25,4	75	48	22,6	-		
PD 72 H 075	3	72	291,06	289,69	263	-	25,4	80	48	22,6	-		
PD 82 H 075	6	82	331,49	330,12	304	-	25,4	80	55	29,6	-		
PD 84 H 075	5	84	339,57	338,20	312	-	25,4	90	55	29,6	19		
PD 94 H 075	5	94	380,00	378,63	352	-	25,4	90	55	29,6	19		
PD 96 H 075	5	96	388,08	386,71	360	-	25,4	100	55	29,6	19		
PD 106 H 075	5	106	428,51	427,14	401	-	25,4	100	55	29,6	19		
PD 116 H 075	5	116	468,93	467,56	441	-	25,4	100	55	29,6	19		
PD 118 H 075	5	118	477,02	475,65	449	-	25,4	100	55	29,6	19		
PD 120 H 075	5	120	485,10	483,73	458	-	25,4	100	55	29,6	19		
PD 150 H 075	5	150	606,38	605,01	579	-	25,4	100	55	29,6	19		
PD 152 H 075	5	152	614,46	613,09	587	-	25,4	100	55	29,6	19		
PD 154 H 075	5	154	622,55	621,17	595	-	25,4	100	55	29,6	19		
PD 156 H 075	5	156	630,63	629,26	603	-	25,4	120	55	29,6	19		

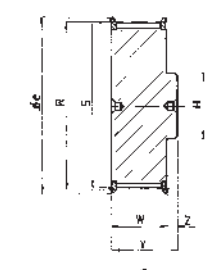

1

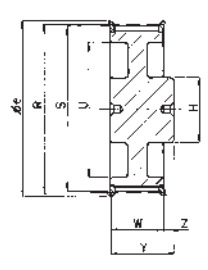

2

PD ... H 100

mm

code Code Code código	type type Typ tipo	teeth dents Zähne dientes	R Ø	S Ø	U Ø	e Ø	W	H Ø	Y	Z	d Ø	flange flasque Bord valona	material materiel Werkstoff material
PD 14 H 100	1	14	56,60	55,23	-	62	33,3	40	44	10,7	-	with flanges avec flasques mit Borde con valona	steel acier Stahl acero
PD 15 H 100	1	15	60,64	59,27	-	67	33,3	45	44	10,7	-		
PD 16 H 100	1	16	64,68	63,31	-	67	33,3	47	44	10,7	-		
PD 17 H 100	1	17	68,72	67,35	-	77	33,3	49	44	10,7	-		
PD 18 H 100	1	18	72,77	71,40	-	80	33,3	57	44	10,7	-		
PD 19 H 100	1	19	76,81	75,44	-	84	33,3	60	44	10,7	-		
PD 20 H 100	1	20	80,85	79,48	-	88	33,3	64	44	10,7	-		
PD 21 H 100	1	21	84,89	83,52	-	94	33,3	64	44	10,7	-		
PD 22 H 100	1	22	88,94	87,57	-	94	33,3	70	44	10,7	-		
PD 23 H 100	1	23	92,98	91,61	-	98	33,3	72	44	10,7	-		
PD 24 H 100	1	24	97,02	95,65	-	104	33,3	80	44	10,7	-		
PD 25 H 100	1	25	101,06	99,69	-	104	33,3	80	44	10,7	-		
PD 26 H 100	1	26	105,11	103,74	-	108	33,3	85	44	10,7	-		
PD 27 H 100	1	27	109,15	107,78	-	113	33,3	88	44	10,7	-		
PD 28 H 100	1	28	113,19	111,92	-	118	33,3	94	44	10,7	-		
PD 29 H 100	1	29	117,23	115,86	-	121	33,3	96	48	14,7	-		
PD 30 H 100	1	30	121,28	119,91	-	129	33,3	104	50	16,7	-		
PD 32 H 100	1	32	129,36	127,99	-	137	33,3	112	52	18,7	-		
PD 33 H 100	1	33	133,40	132,03	-	137	33,3	112	52	18,7	-		
PD 34 H 100	1	34	137,45	136,08	-	142	33,3	118	52	18,7	-		
PD 35 H 100	2	35	141,49	140,12	118	145	33,3	75	52	18,7	-		
PD 36 H 100	2	36	145,53	144,16	118	151	33,3	75	52	18,7	-		
PD 38 H 100	2	38	153,62	152,25	126	158	33,3	75	52	18,7	-		
PD 40 H 100	2	40	161,70	160,33	134	168	33,3	75	54	20,7	-		
PD 44 H 100	2	44	177,87	176,50	150	191	33,3	75	54	20,7	-		
PD 45 H 100	2	45	181,91	180,54	154	189	33,3	75	54	20,7	-		
PD 48 H 100	2	48	194,04	192,67	166	199	33,3	75	60	26,7	-		
PD 49 H 100	3	49	198,08	196,71	170	-	33,3	75	60	26,7	-		
PD 50 H 100	3	50	202,13	200,76	174	-	33,3	75	60	26,7	-		
PD 52 H 100	3	52	210,21	208,84	182	-	33,3	75	60	26,7	-		
PD 60 H 100	3	60	242,55	241,18	215	-	33,3	80	60	26,7	-		
PD 70 H 100	3	70	282,98	281,61	255	-	33,3	80	60	26,7	-		
PD 72 H 100	3	72	291,06	289,69	263	-	33,3	80	60	26,7	-		
PD 82 H 100	6	82	331,49	330,12	304	-	33,3	80	60	26,7	-		
PD 84 H 100	5	84	339,57	338,20	312	-	33,3	90	60	26,7	19		
PD 94 H 100	5	94	380,00	378,63	352	-	33,3	90	60	26,7	19		
PD 96 H 100	5	96	388,08	386,71	360	-	33,3	100	60	26,7	19		
PD 106 H 100	5	106	428,51	427,14	401	-	33,3	100	60	26,7	19		
PD 116 H 100	5	116	468,93	467,56	441	-	33,3	100	60	26,7	19		
PD 118 H 100	5	118	477,02	475,65	449	-	33,3	100	60	26,7	19		
PD 120 H 100	5	120	485,10	483,73	458	-	33,3	100	60	26,7	19		
PD 150 H 100	5	150	606,38	605,01	579	-	33,3	100	60	26,7	19		
PD 152 H 100	5	152	614,46	613,09	587	-	33,3	100	60	26,7	19		
PD 154 H 100	5	154	622,55	621,17	595	-	33,3	100	60	26,7	19		
PD 156 H 100	5	156	630,63	629,26	603	-	33,3	120	60	26,7	19		

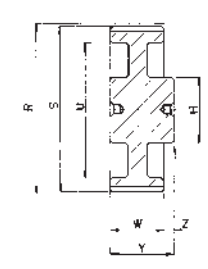

3

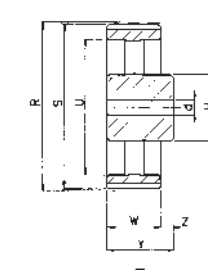

5

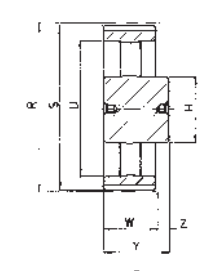

6



PD ... H 150

mm

code Code Código	type type Typ tipo	teeth dents Zähne dientes	R Ø	S Ø	U Ø	e Ø	W	H Ø	Y	Z	d Ø	flange flasque Bord valona	material materiel Werkstoff material
PD 14 H 150	1	14	56,60	55,23	-	62	46	40	58	12	-	with flanges avec flasques mit Borde con valona	steel acier Stahl acero
PD 15 H 150	1	15	60,64	59,27	-	67	46	45	58	12	-		
PD 16 H 150	1	16	64,68	63,31	-	67	46	47	58	12	-		
PD 17 H 150	1	17	68,72	67,35	-	77	46	49	58	12	-		
PD 18 H 150	1	18	72,77	71,40	-	80	46	57	58	12	-		
PD 19 H 150	1	19	76,81	75,44	-	84	46	60	58	12	-		
PD 20 H 150	1	20	80,85	79,48	-	88	46	64	58	12	-		
PD 21 H 150	1	21	84,89	83,52	-	94	46	64	58	12	-		
PD 22 H 150	1	22	88,94	87,57	-	94	46	70	58	12	-		
PD 23 H 150	1	23	92,98	91,61	-	98	46	72	58	12	-		
PD 24 H 150	1	24	97,02	95,65	-	104	46	80	58	12	-		
PD 25 H 150	1	25	101,06	99,69	-	104	46	80	58	12	-		
PD 26 H 150	1	26	105,11	103,74	-	108	46	85	58	12	-		
PD 27 H 150	1	27	109,15	107,78	-	113	46	88	58	12	-		
PD 28 H 150	1	28	113,19	111,92	-	118	46	94	58	12	-		
PD 29 H 150	1	29	117,23	115,86	-	121	46	96	58	12	-		
PD 30 H 150	1	30	121,28	119,91	-	129	46	104	58	12	-		
PD 32 H 150	1	32	129,36	127,99	-	137	46	112	58	12	-		
PD 33 H 150	1	33	133,40	132,03	-	137	46	112	58	12	-		
PD 34 H 150	1	34	137,45	136,08	-	142	46	118	58	12	-		
PD 35 H 150	2	35	141,49	140,12	118	145	46	75	58	22	-		
PD 36 H 150	2	36	145,53	144,16	118	151	46	75	58	22	-		
PD 38 H 150	2	38	153,62	152,25	126	158	46	75	58	22	-		
PD 40 H 150	2	40	161,70	160,33	134	168	46	75	70	24	-		
PD 44 H 150	2	44	177,87	176,50	150	191	46	75	70	24	-		
PD 45 H 150	2	45	181,91	180,54	154	189	46	75	70	24	-		
PD 48 H 150	2	48	194,04	192,67	166	199	46	75	70	24	-		
PD 49 H 150	3	49	198,08	196,71	170	-	46	75	70	24	-		
PD 50 H 150	3	50	202,13	200,76	174	-	46	75	70	24	-		
PD 52 H 150	3	52	210,21	208,84	182	-	46	75	70	24	-		
PD 60 H 150	3	60	242,55	241,18	215	-	46	80	70	24	-		
PD 70 H 150	3	70	282,98	281,61	255	-	46	80	70	24	-		
PD 72 H 150	3	72	291,06	289,69	263	-	46	80	70	24	-		
PD 82 H 150	6	82	331,49	330,12	304	-	46	80	70	24	-		
PD 84 H 150	5	84	339,57	338,20	312	-	46	90	70	24	19		
PD 94 H 150	5	94	380,00	378,63	352	-	46	90	70	24	19		
PD 96 H 150	5	96	388,08	386,71	360	-	46	100	70	24	19		
PD 106 H 150	5	106	428,51	427,14	401	-	46	100	70	24	19		
PD 116 H 150	5	116	468,93	467,56	441	-	46	100	70	24	19		
PD 118 H 150	5	118	477,02	475,65	449	-	46	100	70	24	19		
PD 120 H 150	5	120	485,10	483,73	458	-	46	100	70	24	19		
PD 150 H 150	5	150	606,38	605,01	579	-	46	100	70	24	19		
PD 152 H 150	5	152	614,46	613,09	587	-	46	100	70	24	19		
PD 154 H 150	5	154	622,55	621,17	595	-	46	100	70	24	19		
PD 156 H 150	5	156	630,63	629,26	603	-	46	120	70	24	19		

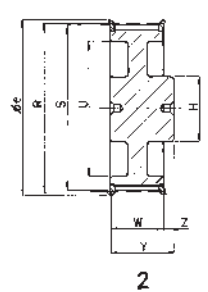
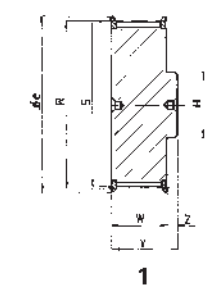

PD ... H 200

mm

code Code Código	type type Typ tipo	teeth dents Zähne dientes	R Ø	S Ø	U Ø	e Ø	W	H Ø	Y	Z	d Ø	flange flasque Bord valona	material materiel Werkstoff material
PD 14 H 200	1	14	56,60	55,23	-	62	59,5	40	72	12,5	-	with flanges avec flasques mit Borde con valona	steel acier Stahl acero
PD 15 H 200	1	15	60,64	59,27	-	67	59,5	45	72	12,5	-		
PD 16 H 200	1	16	64,68	63,31	-	67	59,5	47	72	12,5	-		
PD 17 H 200	1	17	68,72	67,35	-	77	59,5	49	72	12,5	-		
PD 18 H 200	1	18	72,77	71,40	-	80	59,5	57	72	12,5	-		
PD 19 H 200	1	19	76,81	75,44	-	84	59,5	60	72	12,5	-		
PD 20 H 200	1	20	80,85	79,48	-	88	59,5	64	72	12,5	-		
PD 21 H 200	1	21	84,89	83,52	-	94	59,5	64	72	12,5	-		
PD 22 H 200	1	22	88,94	87,57	-	94	59,5	70	72	12,5	-		
PD 23 H 200	1	23	92,98	91,61	-	98	59,5	72	72	12,5	-		
PD 24 H 200	1	24	97,02	95,65	-	104	59,5	80	72	12,5	-		
PD 25 H 200	1	25	101,06	99,69	-	104	59,5	80	72	12,5	-		
PD 26 H 200	1	26	105,11	103,74	-	108	59,5	85	72	12,5	-		
PD 27 H 200	1	27	109,15	107,78	-	113	59,5	88	72	12,5	-		
PD 28 H 200	1	28	113,19	111,92	-	118	59,5	94	72	12,5	-		
PD 29 H 200	1	29	117,23	115,86	-	121	59,5	96	72	12,5	-		
PD 30 H 200	1	30	121,28	119,91	-	129	59,5	104	72	12,5	-		
PD 32 H 200	1	32	129,36	127,99	-	137	59,5	112	72	12,5	-		
PD 33 H 200	1	33	133,40	132,03	-	137	59,5	112	72	12,5	-		
PD 34 H 200	1	34	137,45	136,08	-	142	59,5	118	72	12,5	-		
PD 35 H 200	2	35	141,49	140,12	118	145	59,5	80	72	12,5	-		
PD 36 H 200	2	36	145,53	144,16	118	151	59,5	80	72	12,5	-		
PD 38 H 200	2	38	153,62	152,25	126	158	59,5	80	72	12,5	-		
PD 40 H 200	2	40	161,70	160,33	134	168	59,5	80	72	12,5	-		
PD 44 H 200	2	44	177,87	176,50	150	191	59,5	80	72	12,5	-		
PD 45 H 200	2	45	181,91	180,54	154	189	59,5	80	72	12,5	-		
PD 48 H 200	2	48	194,04	192,67	166	199	59,5	80	80	20,5	-		
PD 49 H 200	3	49	198,08	196,71	170	-	59,5	80	80	20,5	-		
PD 50 H 200	3	50	202,13	200,76	174	-	59,5	80	80	20,5	-		
PD 52 H 200	3	52	210,21	208,84	182	-	59,5	80	80	20,5	-		
PD 60 H 200	3	60	242,55	241,18	215	-	59,5	90	80	20,5	-		
PD 70 H 200	3	70	282,98	281,61	255	-	59,5	90	80	20,5	-		
PD 72 H 200	3	72	291,06	289,69	263	-	59,5	90	80	20,5	-		
PD 82 H 200	6	82	331,49	330,12	304	-	59,5	90	80	20,5	-		
PD 84 H 200	5	84	339,57	338,20	312	-	59,5	100	80	20,5	19		
PD 94 H 200	5	94	380,00	378,63	352	-	59,5	100	80	20,5	19		
PD 96 H 200	5	96	388,08	386,71	360	-	59,5	100	80	20,5	19		
PD 106 H 200	5	106	428,51	427,14	401	-	59,5	100	80	20,5	19		
PD 116 H 200	5	116	468,93	467,56	441	-	59,5	100	80	20,5	19		
PD 118 H 200	5	118	477,02	475,65	449	-	59,5	100	80	20,5	19		
PD 120 H 200	5	120	485,10	483,73	458	-	59,5	120	80	20,5	19		
PD 150 H 200	5	150	606,38	605,01	579	-	59,5	120	80	20,5	19		
PD 152 H 200	5	152	614,46	613,09	587	-	59,5	120	80	20,5	19		
PD 154 H 200	5	154	622,55	621,17	595	-	59,5	120	80	20,5	19		
PD 156 H 200	5	156	630,63	629,26	603	-	59,5	130	80	20,5	19		

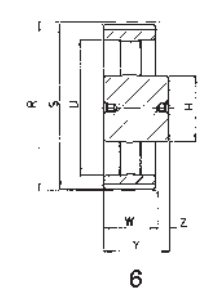
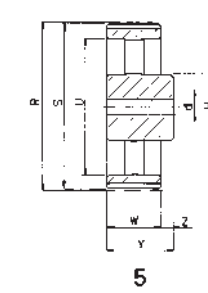
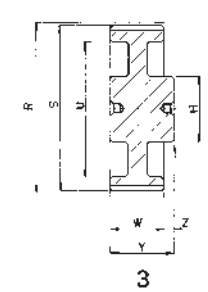

PD ... H 300

code code Code código	type type Typ tipo	teeth dents Zähne dientes	R Ø	S Ø	U Ø	e Ø	W	H Ø	Y	Z	d Ø	flange flasque Bord valona	material materiel Werkstoff material
PD 14 H 300	1	14	56,60	55,23	-	62	85,7	40	98	12,3	-	with flanges avec flasques mit Borde con valona	steel acier Stahl acero
PD 15 H 300	1	15	60,64	59,27	-	67	85,7	45	98	12,3	-		
PD 16 H 300	1	16	64,68	63,31	-	67	85,7	47	98	12,3	-		
PD 17 H 300	1	17	68,72	67,35	-	77	85,7	49	98	12,3	-		
PD 18 H 300	1	18	72,77	71,40	-	80	85,7	57	98	12,3	-		
PD 19 H 300	1	19	76,81	75,44	-	84	85,7	60	98	12,3	-		
PD 20 H 300	1	20	80,85	79,48	-	88	85,7	64	98	12,3	-		
PD 21 H 300	1	21	84,89	83,52	-	94	85,7	64	98	12,3	-		
PD 22 H 300	1	22	88,94	87,57	-	94	85,7	70	98	12,3	-		
PD 23 H 300	1	23	92,98	91,61	-	98	85,7	72	98	12,3	-		
PD 24 H 300	1	24	97,02	95,65	-	104	85,7	80	98	12,3	-		
PD 25 H 300	1	25	101,06	99,69	-	104	85,7	80	98	12,3	-		
PD 26 H 300	1	26	105,11	103,74	-	108	85,7	85	98	12,3	-		
PD 27 H 300	1	27	109,15	107,78	-	113	85,7	88	98	12,3	-		
PD 28 H 300	1	28	113,19	111,92	-	118	85,7	94	98	12,3	-		
PD 29 H 300	1	29	117,23	115,86	-	121	85,7	96	98	12,3	-		
PD 30 H 300	1	30	121,28	119,91	-	129	85,7	104	98	12,3	-		
PD 32 H 300	1	32	129,36	127,99	-	137	85,7	112	98	12,3	-		
PD 33 H 300	1	33	133,40	132,03	-	137	85,7	112	98	12,3	-		
PD 34 H 300	1	34	137,45	136,08	-	142	85,7	118	98	12,3	-		
PD 35 H 300	2	35	141,49	140,12	118	145	85,7	75	98	12,3	-		
PD 36 H 300	2	36	145,53	144,16	118	151	85,7	80	98	12,3	-		
PD 38 H 300	2	38	153,62	152,25	126	158	85,7	80	98	12,3	-		
PD 40 H 300	2	40	161,70	160,33	134	168	85,7	80	98	12,3	-		
PD 44 H 300	2	44	177,87	176,50	150	191	85,7	80	98	12,3	-		
PD 45 H 300	2	45	181,91	180,54	154	189	85,7	80	98	12,3	-		
PD 48 H 300	2	48	194,04	192,67	166	199	85,7	90	98	12,3	-		
PD 49 H 300	3	49	198,08	196,71	170	-	85,7	90	98	12,3	-		
PD 50 H 300	3	50	202,13	200,76	174	-	85,7	90	98	12,3	-		
PD 52 H 300	3	52	210,21	208,84	182	-	85,7	90	98	12,3	-		
PD 60 H 300	3	60	242,55	241,18	215	-	85,7	100	98	12,3	-		
PD 70 H 300	3	70	282,98	281,61	255	-	85,7	100	98	12,3	-		
PD 72 H 300	3	72	291,06	289,69	263	-	85,7	100	98	12,3	-		
PD 82 H 300	6	82	331,49	330,12	304	-	85,7	100	98	12,3	-		
PD 84 H 300	5	84	339,57	338,20	312	-	85,7	100	98	12,3	19		
PD 94 H 300	5	94	380,00	378,63	352	-	85,7	100	98	12,3	19		
PD 96 H 300	5	96	388,08	386,71	360	-	85,7	110	98	12,3	19		
PD 106 H 300	5	106	428,51	427,14	401	-	85,7	110	98	12,3	19		
PD 116 H 300	5	116	468,93	467,56	441	-	85,7	110	98	12,3	19		
PD 118 H 300	5	118	477,02	475,65	449	-	85,7	110	98	12,3	19		
PD 120 H 300	5	120	485,10	483,73	458	-	85,7	120	98	12,3	19		
PD 150 H 300	5	150	606,38	605,01	579	-	85,7	120	98	12,3	19		
PD 152 H 300	5	152	614,46	613,09	587	-	85,7	120	98	12,3	19		
PD 154 H 300	5	154	622,55	621,17	595	-	85,7	120	98	12,3	19		
PD 156 H 300	5	156	630,63	629,26	603	-	85,7	130	98	12,3	19		

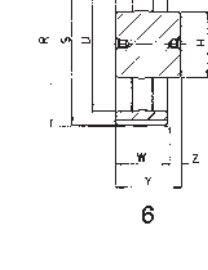
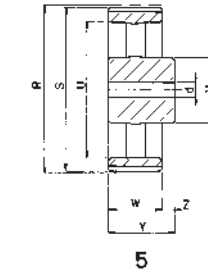
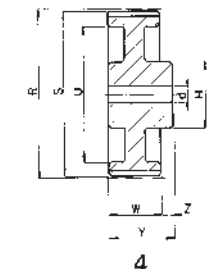
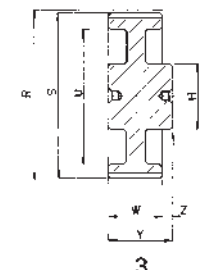
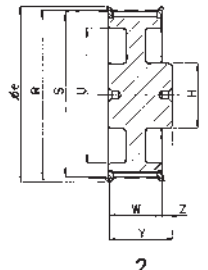
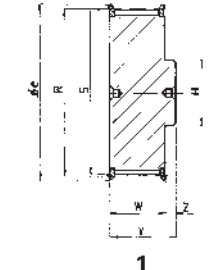

PD ... XH 200

code code Code código	type type Typ tipo	teeth dents Zähne dientes	R Ø	S Ø	U Ø	e Ø	W	H Ø	Y	Z	d Ø	flange flasque Bord valona	material materiel Werkstoff material
PD 18 XH 200	1	18	127,34	124,55	-	134	65	100	80	15	-	with flanges avec flasques mit Borde con valona	cast iron fonte Grauguss fundición
PD 19 XH 200	1	19	134,41	131,62	-	142	65	107	80	15	-		
PD 20 XH 200	1	20	141,49	138,70	-	150	65	114	80	15	-		
PD 21 XH 200	1	21	148,56	145,77	-	158	65	122	80	15	-		
PD 22 XH 200	1	22	155,64	152,85	-	166	65	128	80	15	-		
PD 24 XH 200	1	24	169,79	167,00	-	177	65	141	80	15	-		
PD 25 XH 200	2	25	176,86	174,07	-	186	65	90	80	15	-		
PD 26 XH 200	2	26	183,94	171,15	-	191	65	90	80	15	-		
PD 27 XH 200	1	27	191,01	188,22	-	200	65	158	80	15	-		
PD 28 XH 200	1	28	198,08	195,29	-	199	65	169	80	15	-		
PD 30 XH 200	2	30	212,23	209,44	170	216	65	100	80	15	-		
PD 32 XH 200	2	32	226,38	223,59	184	232	65	110	80	15	-		
PD 34 XH 200	2	34	240,53	237,74	198	261	65	110	80	15	-		
PD 38 XH 200	2	38	268,83	266,03	227	274	65	110	80	15	-		
PD 40 XH 200	2	40	282,98	280,19	241	288	65	120	100	35	-		
PD 46 XH 200	3	46	325,42	322,63	283	-	65	120	100	35	-		
PD 48 XH 200	4	48	339,57	336,78	297	-	65	120	100	35	19		
PD 58 XH 200	4	58	410,32	407,52	368	-	65	120	100	35	19		
PD 60 XH 200	4	60	424,47	421,68	382	-	65	130	100	35	19		
PD 70 XH 200	5	70	495,21	492,42	453	-	65	130	100	35	19		
PD 72 XH 200	5	72	509,36	506,57	467	-	65	140	100	35	19		
PD 78 XH 200	5	78	551,80	549,01	510	-	65	140	100	35	19		
PD 80 XH 200	5	80	565,95	563,16	524	-	65	140	100	35	19		
PD 82 XH 200	5	82	580,10	577,31	538	-	65	140	100	35	19		
PD 84 XH 200	5	84	594,25	591,46	552	-	65	150	100	35	19		
PD 94 XH 200	5	94	664,99	662,20	623	-	65	150	100	35	19		
PD 96 XH 200	5	96	679,14	676,35	637	-	65	160	100	35	19		
PD 118 XH 200	5	118	834,78	831,99	792	-	65	160	100	35	19		
PD 120 XH 200	5	120	848,93	846,14	806	-	65	170	100	35	19		



PD ... XH 300

mm

code code Code código	type type Typ tipo	teeth dents Zähne dientes	R Ø	S Ø	U Ø	e Ø	W	H Ø	Y	Z	d Ø	flange flasque Bord valona	material materiel Werkstoff material
PD 18 XH 300	1	18	127,34	124,55	-	134	92	100	107	15	-	with flanges avec flasques mit Borde con valona	cast iron fonte Grauguss fundición
PD 19 XH 300	1	19	134,41	131,62	-	142	92	107	107	15	-		
PD 20 XH 300	1	20	141,49	138,70	-	150	92	114	107	15	-		
PD 21 XH 300	1	21	148,56	145,77	-	158	92	122	107	15	-		
PD 22 XH 300	1	22	155,64	152,85	-	166	92	128	107	15	-		
PD 24 XH 300	1	24	169,79	167,00	-	177	92	141	107	15	-		
PD 25 XH 300	1	25	176,86	174,07	-	186	92	148	107	15	-		
PD 26 XH 300	1	26	183,94	171,15	-	191	92	157	107	15	-		
PD 27 XH 300	1	27	191,01	188,22	-	200	92	158	107	15	-		
PD 28 XH 300	1	28	198,08	195,29	-	199	92	169	107	15	-		
PD 30 XH 300	2	30	212,23	209,44	170	216	92	110	107	15	-		
PD 32 XH 300	2	32	226,38	223,59	184	232	92	110	107	15	-		
PD 34 XH 300	2	34	240,53	237,74	198	261	92	110	107	15	-		
PD 38 XH 300	2	38	268,83	266,03	227	274	92	110	107	15	-		
PD 40 XH 300	2	40	282,98	280,19	241	288	92	120	100	8	-		
PD 46 XH 300	3	46	325,42	322,63	283	-	92	120	100	8	-		
PD 48 XH 300	4	48	339,57	336,78	297	-	92	120	100	8	19		
PD 58 XH 300	4	58	410,32	407,52	368	-	92	120	100	8	19		
PD 60 XH 300	4	60	424,47	421,68	382	-	92	120	100	8	19		
PD 70 XH 300	5	70	495,21	492,42	453	-	92	130	100	8	19		
PD 72 XH 300	5	72	509,36	506,57	467	-	92	140	120	28	19		
PD 78 XH 300	5	78	551,80	549,01	510	-	92	140	120	28	19		
PD 80 XH 300	5	80	565,95	563,16	524	-	92	140	120	28	19		
PD 82 XH 300	5	82	580,10	577,31	538	-	92	140	120	28	19		
PD 84 XH 300	5	84	594,25	591,46	552	-	92	160	120	28	19		
PD 94 XH 300	5	94	664,99	662,20	623	-	92	150	120	28	19		
PD 96 XH 300	5	96	679,14	676,35	637	-	92	160	120	28	19		
PD 118 XH 300	5	118	834,78	831,99	792	-	92	160	120	28	19		
PD 120 XH 300	5	120	848,93	846,14	806	-	92	170	120	28	19		

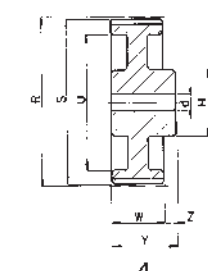
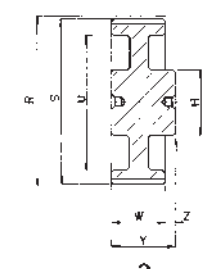
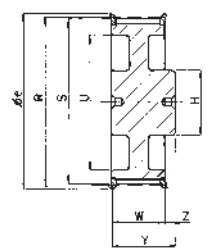
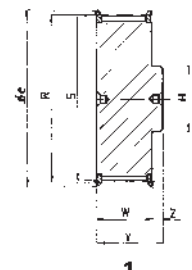

PD ... XH 400

mm

code code Code código	type type Typ tipo	teeth dents Zähne dientes	R Ø	S Ø	U Ø	e Ø	W	H Ø	Y	Z	d Ø	flange flasque Bord valona	material materiel Werkstoff material
PD 18 XH 400	1	18	127,34	124,55	-	134	119	100	135	16	-	with flanges avec flasques mit Borde con valona	cast iron fonte Grauguss fundición
PD 19 XH 400	1	19	134,41	131,62	-	142	119	107	135	16	-		
PD 20 XH 400	1	20	141,49	138,70	-	150	119	114	135	16	-		
PD 21 XH 400	1	21	148,56	145,77	-	158	119	122	135	16	-		
PD 22 XH 400	1	22	155,64	152,85	-	166	119	128	135	16	-		
PD 24 XH 400	1	24	169,79	167,00	-	177	119	141	135	15	-		
PD 25 XH 400	1	25	176,86	174,07	-	186	119	148	135	16	-		
PD 26 XH 400	1	26	183,94	171,15	-	191	119	157	135	16	-		
PD 27 XH 400	1	27	191,01	188,22	-	200	119	158	135	16	-		
PD 28 XH 400	1	28	198,08	195,29	-	199	119	169	135	15	-		
PD 30 XH 400	2	30	212,23	209,44	170	216	119	120	135	16	-		
PD 32 XH 400	2	32	226,38	223,59	184	232	119	120	135	15	-		
PD 34 XH 400	2	34	240,53	237,74	198	261	119	120	135	15	-		
PD 38 XH 400	2	38	268,83	266,03	227	274	119	120	135	15	-		
PD 40 XH 400	2	40	282,98	280,19	241	288	119	120	135	16	-		
PD 46 XH 400	3	46	325,42	322,63	283	-	119	140	135	16	-		
PD 48 XH 400	4	48	339,57	336,78	297	-	119	140	135	16	19		
PD 58 XH 400	4	58	410,32	407,52	368	-	119	140	135	16	19		
PD 60 XH 400	4	60	424,47	421,68	382	-	119	140	135	16	19		
PD 70 XH 400	5	70	495,21	492,42	453	-	119	140	135	16	19		
PD 72 XH 400	5	72	509,36	506,57	467	-	119	140	135	16	19		
PD 78 XH 400	5	78	551,80	549,01	510	-	119	140	135	16	19		
PD 80 XH 400	5	80	565,95	563,16	524	-	119	140	135	16	19		
PD 82 XH 400	5	82	580,10	577,31	538	-	119	140	135	16	19		
PD 84 XH 400	5	84	594,25	591,46	552	-	119	160	135	16	19		
PD 94 XH 400	5	94	664,99	662,20	623	-	119	150	135	16	19		
PD 96 XH 400	5	96	679,14	676,35	637	-	119	160	135	16	19		
PD 118 XH 400	5	118	834,78	831,99	792	-	119	160	135	16	19		
PD 120 XH 400	5	120	848,93	846,14	806	-	119	170	135	16	19		

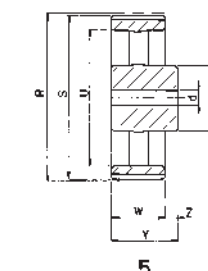

PD ... XXH 200

mm

Codice	Tipo	N. denti	R Ø	S Ø	U Ø	e Ø	W	H Ø	Y	Z	d Ø	Flange	Materiale
PD 18 XXH 200	1	18	181,91	178,86	-	186	67	150	100	33	-	with flanges avec flasques mit Borde con valona	cast iron fonte Grauguss fundición
PD 19 XXH 200	1	19	192,02	188,97	-	200	67	150	100	33	-		
PD 20 XXH 200	1	20	202,13	199,08	-	209	67	150	100	33	-		
PD 21 XXH 200	1	21	212,23	209,18	-	216	67	150	100	33	-		
PD 22 XXH 200	1	22	222,34	219,29	-	232	67	150	100	33	-		
PD 24 XXH 200	1	24	242,55	239,50	-	261	67	150	100	33	-		
PD 25 XXH 200	3	25	252,66	249,61	196	-	67	150	100	33	-		
PD 26 XXH 200	3	26	262,76	259,71	207	-	67	150	100	33	-		
PD 27 XXH 200	3	27	272,87	269,82	216	-	67	150	100	33	-		
PD 30 XXH 200	3	30	303,19	300,14	247	-	67	170	100	33	-		
PD 34 XXH 200	4	34	343,62	340,57	287	-	67	170	100	33	19		
PD 40 XXH 200	4	40	404,25	401,20	348	-	67	170	100	33	19		
PD 48 XXH 200	5	48	485,10	482,05	429	-	67	180	120	53	19		
PD 60 XXH 200	5	60	606,38	603,33	547	-	67	180	120	53	19		
PD 72 XXH 200	5	72	727,66	724,61	668	-	67	180	120	53	19		
PD 90 XXH 200	5	90	909,57	906,52	850	-	67	180	120	53	19		

PD ... XXH 300

mm

code code Code Código	type type Typ tipo	teeth dents Zähne dientes	R Ø	S Ø	U Ø	e Ø	W	H Ø	Y	Z	d Ø	flange flasque Bord valona	material materiel Werkstoff material
PD 18 XXH 300	1	18	181,91	178,86	-	186	94	150	110	16	-	with flanges avec flasques mit Borde con valona	cast iron fonte Grauguss fundición
PD 19 XXH 300	1	19	192,02	188,97	-	200	94	150	110	16	-		
PD 20 XXH 300	1	20	202,13	199,08	-	209	94	150	110	16	-		
PD 21 XXH 300	1	21	212,23	209,18	-	216	94	150	110	16	-		
PD 22 XXH 300	1	22	222,34	219,29	-	232	94	150	110	16	-		
PD 24 XXH 300	1	24	242,55	239,50	-	261	94	150	110	16	-	without flanges sous flasques ohne Borde sin valona	
PD 25 XXH 300	3	25	252,66	249,61	196	-	94	150	110	16	-		
PD 26 XXH 300	3	26	262,76	259,71	207	-	94	150	110	16	-		
PD 27 XXH 300	3	27	272,87	269,82	216	-	94	150	110	16	-		
PD 30 XXH 300	3	30	303,19	300,14	247	-	94	170	110	16	-		
PD 34 XXH 300	4	34	343,62	340,57	287	-	94	170	110	16	19		
PD 40 XXH 300	4	40	404,25	401,20	348	-	94	170	110	16	19		
PD 48 XXH 300	5	48	485,10	482,05	429	-	94	180	120	26	19		
PD 60 XXH 300	5	60	606,38	603,33	547	-	94	180	120	26	19		
PD 72 XXH 300	5	72	727,66	724,61	668	-	94	180	120	26	19		
PD 90 XXH 300	5	90	909,57	906,52	850	-	94	180	120	26	19		

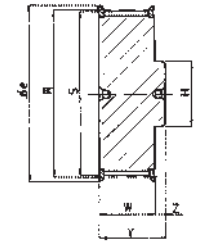

1

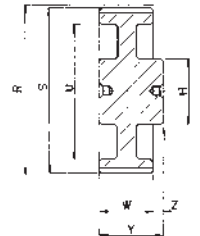

3

PD ... XXH 400

mm

code code Code Código	type type Typ tipo	teeth dents Zähne dientes	R Ø	S Ø	U Ø	e Ø	W	H Ø	Y	Z	d Ø	flange flasque Bord valona	material materiel Werkstoff material
PD 18 XXH 400	1	18	181,91	178,86	-	186	121	150	140	19	-	with flanges avec flasques mit Borde con valona	cast iron fonte Grauguss fundición
PD 19 XXH 400	1	19	192,02	188,97	-	200	121	150	140	19	-		
PD 20 XXH 400	1	20	202,13	199,08	-	209	121	150	140	19	-		
PD 21 XXH 400	1	21	212,23	209,18	-	216	121	150	140	19	-		
PD 22 XXH 400	1	22	222,34	219,29	-	232	121	150	140	19	-		
PD 24 XXH 400	1	24	242,55	239,50	-	261	121	150	140	19	-	without flanges sous flasques ohne Borde sin valona	
PD 25 XXH 400	7	25	252,66	249,61	196	-	121	150	140	19	-		
PD 26 XXH 400	3	26	262,76	259,71	207	-	121	170	140	19	-		
PD 27 XXH 400	3	27	272,87	269,82	216	-	121	170	140	19	-		
PD 30 XXH 400	3	30	303,19	300,14	247	-	121	170	140	19	-		
PD 34 XXH 400	4	34	343,62	340,57	287	-	121	180	140	19	19		
PD 40 XXH 400	4	40	404,25	401,20	348	-	121	180	110	19	19		
PD 48 XXH 400	5	48	485,10	482,05	429	-	121	180	140	19	19		
PD 60 XXH 400	5	60	606,38	603,33	547	-	121	220	140	19	19		
PD 72 XXH 400	5	72	727,66	724,61	668	-	121	220	140	19	19		
PD 90 XXH 400	5	90	909,57	906,52	850	-	121	220	140	19	19		

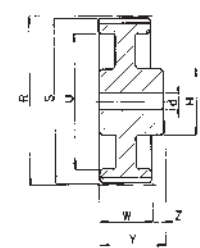

4

PD ... XXH 500

mm

code code Code Código	type type Typ tipo	teeth dents Zähne dientes	R Ø	S Ø	U Ø	e Ø	W	H Ø	Y	Z	d Ø	flange flasque Bord valona	material materiel Werkstoff material
PD 18 XXH 500	1	18	181,91	178,86	-	186	148	150	168	20	-	with flanges avec flasques mit Borde con valona	cast iron fonte Grauguss fundición
PD 19 XXH 500	1	19	192,02	188,97	-	200	148	150	168	20	-		
PD 20 XXH 500	1	20	202,13	199,08	-	209	148	150	168	20	-		
PD 21 XXH 500	1	21	212,23	209,18	-	216	148	150	168	20	-		
PD 22 XXH 500	1	22	222,34	219,29	-	232	148	150	168	20	-		
PD 24 XXH 500	1	24	242,55	239,50	-	261	148	170	168	20	-	without flanges sous flasques ohne Borde sin valona	
PD 25 XXH 500	3	25	252,66	249,61	196	-	148	170	168	20	-		
PD 26 XXH 500	3	26	262,76	259,71	207	-	148	170	168	20	-		
PD 27 XXH 500	3	27	272,87	269,82	216	-	148	180	168	20	-		
PD 30 XXH 500	3	30	303,19	300,14	247	-	148	180	168	20	-		
PD 34 XXH 500	4	34	343,62	340,57	287	-	148	180	168	20	19		
PD 40 XXH 500	4	40	404,25	401,20	348	-	148	180	168	20	19		
PD 48 XXH 500	5	48	485,10	482,05	429	-	148	220	168	20	19		
PD 60 XXH 500	5	60	606,38	603,33	547	-	148	220	168	20	19		
PD 72 XXH 500	5	72	727,66	724,61	668	-	148	220	168	20	19		
PD 90 XXH 500	5	90	909,57	906,52	850	-	148	220	168	20	19		

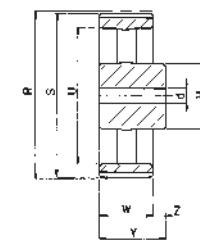

5

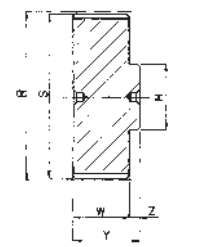

7

STANDARD TIMING PULLEYS FOR ASSEMBLY WITH SER-SIT® CONICAL BUSHES
POULIES DENTEES DE SERIE POUR MONTAGE AVEC MOYEU AMOVIBLE SER-SIT®
STANDARD-ZAHNSCHEIBEN ZUR MONTAGE MIT SER-SIT® SPANNBUCHSEN
POLEAS DENTADAS DE SERIE PARA MONTAJE CON BUJE CONICO SER-SIT®

PBD ... L 050

mm

code code Code código	type type Typ tipo	bushing moyeu Spannbuchse bujie		R Ø	S Ø	U Ø	e Ø	W	H Ø	Y	Z	flange flasque Bord valona	material materiel Werkstoff material
		type type Typ tipo	bore alesage Bohrung bujie máx										
PBD 18 L 050	1	1108	28	54,57	53,81	-	62	19	47	22	3	with flanges avec flasques mit Borde con valona	cast iron fonte Grauguss fundición
PBD 19 L 050	1	1108	28	57,61	56,84	-	62	19	47	22	3		
PBD 20 L 050	1	1108	28	60,64	59,88	-	67	19	48	22	3		
PBD 21 L 050	1	1108	28	63,67	62,91	-	67	19	48	22	3		
PBD 22 L 050	1	1108	28	66,70	65,94	-	73	19	51	22	3		
PBD 23 L 050	1	1108	28	69,73	68,97	-	73	19	51	22	3		
PBD 24 L 050	1	1108	28	72,77	72,01	-	80	19	58	22	3		
PBD 25 L 050	1	1108	28	75,80	75,04	-	80	19	58	22	3		
PBD 26 L 050	1	1108	28	78,83	78,07	-	88	19	58	22	3		
PBD 27 L 050	1	1108	28	81,86	81,10	-	88	19	58	22	3		
PBD 28 L 050	1	1108	28	84,89	84,13	-	94	19	58	22	3		
PBD 29 L 050	1	1108	28	87,93	87,16	-	94	19	58	22	3		
PBD 30 L 050	1	1108	28	90,96	90,20	-	98	19	58	22	3		
PBD 32 L 050	1	1108	28	97,02	96,26	-	100	19	58	22	3		
PBD 33 L 050	1	1108	28	100,05	99,29	-	108	19	58	22	3		
PBD 34 L 050	1	1108	28	103,08	102,32	-	108	19	58	22	3		
PBD 35 L 050	6	1108	28	106,12	105,35	84	113	19	58	22	3		
PBD 36 L 050	6	1108	28	109,15	108,39	84	113	19	58	22	3		
PBD 40 L 050	1	1610	42	121,28	120,52	-	129	19	90	25	6		
PBD 41 L 050	1	1610	42	124,31	123,55	-	129	19	90	25	6		
PBD 42 L 050	6	1610	42	127,34	126,58	110	137	19	90	25	6		
PBD 44 L 050	6	1610	42	133,40	132,64	110	142	19	90	25	6		
PBD 45 L 050	6	1610	42	136,44	135,67	118	142	19	90	25	6		
PBD 47 L 050	6	1610	42	142,50	141,74	126	149	19	90	25	6		
PBD 48 L 050	6	1610	42	145,53	144,77	126	151	19	90	25	6		
PBD 49 L 050	9	1610	42	148,56	147,80	132	-	19	90	25	6		
PBD 50 L 050	9	1610	42	151,60	150,83	132	-	19	90	25	6		
PBD 52 L 050	9	1610	42	157,66	156,90	138	-	19	90	25	6		
PBD 56 L 050	9	1610	42	169,79	169,02	152	-	19	90	25	6		
PBD 57 L 050	9	1610	42	172,82	172,06	152	-	19	90	25	6		
PBD 60 L 050	16	1610	42	181,91	181,15	162	-	19	90	25	3		
PBD 65 L 050	13	1610	42	197,07	196,31	178	-	19	90	25	3		
PBD 66 L 050	13	1610	42	200,11	199,34	178	-	19	90	25	3		
PBD 72 L 050	13	1610	42	218,30	217,54	199	-	19	90	25	3		
PBD 84 L 050	13	1610	42	254,68	253,92	235	-	19	90	25	3		
PBD 90 L 050	13	1610	42	272,87	272,11	253	-	19	90	25	3		
PBD 96 L 050	13	2012	50	291,06	290,30	270	-	19	110	32	6,5		
PBD 120 L 050	13	2012	50	363,83	363,07	344	-	19	110	32	6,5		

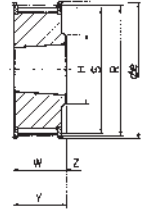

1

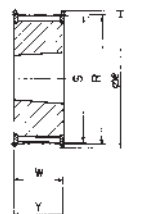

2

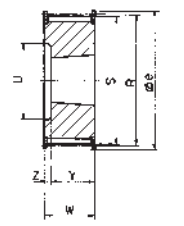

4

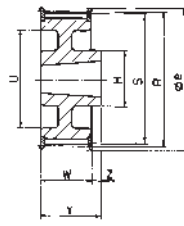

6

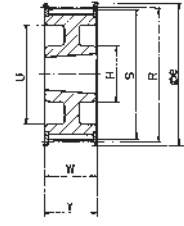

7

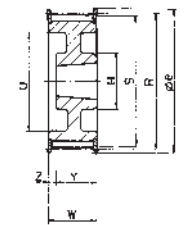

8

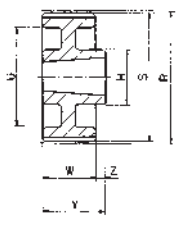

9

PBD ... L 075

mm

code code Code código	type type Typ tipo	bushing moyeu Spannbuchse bujie		R Ø	S Ø	U Ø	e Ø	W	H Ø	Y	Z	flange flasque Bord valona	material materiel Werkstoff material
		type type Typ tipo	bore alesage Bohrung bujie máx										
PBD 18 L 075	4	1108	28	54,57	53,81	38	62	25	-	22	3	with flanges avec flasques mit Borde con valona	cast iron fonte Grauguss fundición
PBD 19 L 075	4	1108	28	57,61	56,84	38	62	25	-	22	3		
PBD 20 L 075	4	1108	28	60,64	59,88	46	67	25	-	22	3		
PBD 21 L 075	4	1108	28	63,67	62,91	46	67	25	-	22	3		
PBD 22 L 075	4	1108	28	66,70	65,94	46	73	25	-	22	3		
PBD 23 L 075	4	1108	28	69,73	68,97	46	73	25	-	22	3		
PBD 24 L 075	4	1108	28	72,77	72,01	53	80	25	-	22	3		
PBD 25 L 075	4	1108	28	75,80	75,04	53	80	25	-	22	3		
PBD 26 L 075	4	1108	28	78,83	78,07	60	88	25	-	22	3		
PBD 27 L 075	4	1108	28	81,86	81,10	60	88	25	-	22	3		
PBD 28 L 075	4	1108	28	84,89	84,13	65	94	25	-	22	3		
PBD 29 L 075	4	1108	28	87,93	87,16	65	94	25	-	22	3		
PBD 30 L 075	4	1108	28	90,96	90,20	68	98	25	-	22	3		
PBD 32 L 075	4	1108	28	97,02	96,26	76	100	25	-	22	3		
PBD 33 L 075	4	1108	28	100,05	99,29	83	108	25	-	22	3		
PBD 34 L 075	4	1108	28	103,08	102,32	85	108	25	-	22	3		
PBD 35 L 075	2	1610	42	106,12	105,35	-	113	25	-	25	-		
PBD 36 L 075	2	1610	42	109,15	108,39	-	113	25	-	25	-		
PBD 40 L 075	2	1610	42	121,28	120,52	-	129	25	-	25	-		
PBD 41 L 075	2	1610	42	124,31	123,55	-	129	25	-	25	-		
PBD 42 L 075	7	1610	42	127,34	126,58	110	137	25	90	25	-		
PBD 44 L 075	7	1610	42	133,40	132,64	110	142	25	90	25	-		
PBD 45 L 075	7	1610	42	136,44	135,67	118	142	25	90	25	-		
PBD 47 L 075	7	1610	42	142,50	141,74	126	149	25	90	25	-		
PBD 48 L 075	7	1610	42	145,53	144,77	126	151	25	90	25	-		
PBD 49 L 075	10	1610	42	148,56	147,80	132	-	25	90	25	-		
PBD 50 L 075	10	1610	42	151,60	150,83	132	-	25	90	25	-		
PBD 52 L 075	10	1610	42	157,66	156,90	138	-	25	90	25	-		
PBD 56 L 075	10	1610	42	169,79	169,02	152	-	25	90	25	-		
PBD 57 L 075	10	1610	42	172,82	172,06	152	-	25	90	25	-		
PBD 60 L 075	10	1610	42	181,91	181,15	162	-	25	90	25	-		
PBD 65 L 075	10	1610	42	197,07	196,31	178	-	25	90	25	-		
PBD 66 L 075	10	1610	42	200,11	199,34	178	-	25	90	25	-		
PBD 72 L 075	14	1610	42	218,30	217,54	199	-	25	90	25	-		
PBD 84 L 075	13	2012	50	254,68	253,92	235	-	25	110	32	3,5		
PBD 90 L 075	13	2012	50	272,87	272,11	253	-	25	110	32	3,5		
PBD 96 L 075	13	2012	50	291,06	290,30	270	-	25	110	32	3,5		
PBD 120 L 075	13	2012	50	363,83	363,07	344	-	25	110	32	3,5		

PBD ... L 100

mm

code code Code código	type type Typ tipo	bushing moyeu Spannbuchse bujie		R Ø	S Ø	U Ø	e Ø	W	H Ø	Y	Z	flange flasque Bord valona	material materiel Werkstoff material
		type type Typ tipo	bore alesage Bohrung bujie max										
PBD 18 L 100	4	1108	28	54,57	53,81	38	62	32	-	22	10	with flanges avec flasques mit Borde con valona	cast iron fonte Grauguss fundición
PBD 19 L 100	4	1108	28	57,61	56,84	38	62	32	-	22	10		
PBD 20 L 100	4	1108	28	60,64	59,88	46	67	32	-	22	10		
PBD 21 L 100	4	1108	28	63,67	62,91	46	67	32	-	22	10		
PBD 22 L 100	4	1108	28	66,70	65,94	46	73	32	-	22	10		
PBD 23 L 100	4	1108	28	69,73	68,97	46	73	32	-	22	10		
PBD 24 L 100	4	1108	28	72,77	72,01	53	80	32	-	22	10		
PBD 25 L 100	4	1108	28	75,80	75,04	53	80	32	-	22	10		
PBD 26 L 100	4	1108	28	78,83	78,07	60	88	32	-	22	10		
PBD 27 L 100	4	1108	28	81,86	81,10	60	88	32	-	22	10		
PBD 28 L 100	4	1108	28	84,89	84,13	65	94	32	-	22	10		
PBD 29 L 100	4	1210	32	87,93	87,16	68	94	32	-	25	7		
PBD 30 L 100	4	1210	32	90,96	90,20	68	98	32	-	25	7		
PBD 32 L 100	4	1210	32	97,02	96,26	76	100	32	-	25	7		
PBD 33 L 100	4	1610	42	100,05	99,29	83	108	32	-	25	7		
PBD 34 L 100	4	1610	42	103,08	103,32	85	108	32	-	25	7		
PBD 35 L 100	4	1610	42	106,12	105,35	85	113	32	-	25	7		
PBD 36 L 100	4	1610	42	109,15	108,39	85	113	32	-	25	7		
PBD 40 L 100	4	1610	42	121,28	120,52	100	129	32	-	25	7		
PBD 41 L 100	4	1610	42	124,31	123,55	100	129	32	-	25	7		
PBD 42 L 100	8	1610	42	127,34	126,58	110	137	32	90	25	7		
PBD 44 L 100	8	1610	42	133,40	132,64	110	142	32	90	25	7		
PBD 45 L 100	8	1610	42	136,44	135,67	118	142	32	90	25	7		
PBD 47 L 100	8	1610	42	142,50	141,74	126	149	32	90	25	7		
PBD 48 L 100	8	1610	42	145,53	144,77	126	151	32	90	25	7		
PBD 49 L 100	11	1610	42	148,56	147,80	132	-	32	90	25	7		
PBD 50 L 100	11	1610	42	151,60	150,83	132	-	32	90	25	7		
PBD 52 L 100	11	1610	42	157,66	156,90	138	-	32	90	25	7		
PBD 56 L 100	11	1610	42	169,79	169,02	152	-	32	90	25	7		
PBD 57 L 100	11	1610	42	172,82	172,06	152	-	32	90	25	7		
PBD 60 L 100	12	1610	42	181,91	181,15	162	-	32	90	25	3,5		
PBD 65 L 100	12	1610	42	197,07	196,31	178	-	32	90	25	3,5		
PBD 66 L 100	12	1610	42	200,11	199,34	178	-	32	90	25	3,5		
PBD 72 L 100	10	2012	50	218,30	217,54	199	-	32	110	32	-		
PBD 84 L 100	14	2012	50	254,68	253,92	235	-	32	110	32	-		
PBD 90 L 100	14	2012	50	272,87	272,11	253	-	32	110	32	-		
PBD 96 L 100	14	2012	50	291,06	290,30	270	-	32	110	32	-		
PBD 120 L 100	14	2012	50	363,83	363,07	344	-	32	110	32	-		

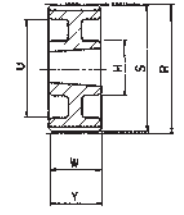

10

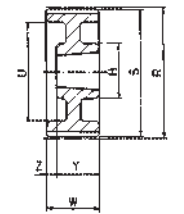

11

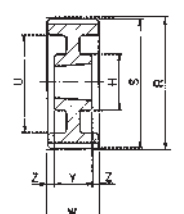

12

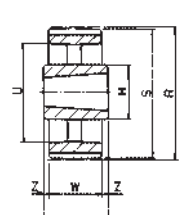

13

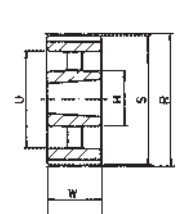

14

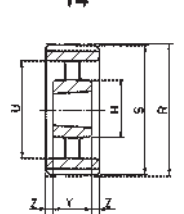

15

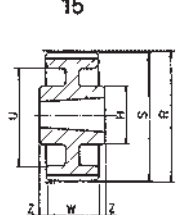

16

PBD ... H 100

mm

code code Code código	type type Typ tipo	bushing moyeu Spannbuchse bujie		R Ø	S Ø	U Ø	e Ø	W	H Ø	Y	Z	flange flasque Bord valona	material materiel Werkstoff material
		type type Typ tipo	bore alesage Bohrung bujie max										
PBD 14 H 100	4	1108	28	56,60	55,23	37	62	31	-	22	9	with flanges avec flasques mit Borde con valona	cast iron fonte Grauguss fundición
PBD 15 H 100	4	1108	28	60,64	59,27	37	67	31	-	22	9		
PBD 16 H 100	4	1108	28	64,68	63,31	46	67	31	-	22	9		
PBD 17 H 100	4	1210	32	68,72	67,35	46	77	31	-	25	6		
PBD 18 H 100	4	1210	32	72,77	71,40	56	80	31	-	25	6		
PBD 19 H 100	4	1210	32	76,81	75,44	56	84	31	-	25	6		
PBD 20 H 100	4	1210	32	80,85	79,48	56	88	31	-	25	6		
PBD 21 H 100	4	1210	32	84,89	83,52	62	94	32	-	25	7		
PBD 22 H 100	4	1210	32	88,94	87,57	62	94	32	-	25	7		
PBD 23 H 100	4	1610	42	92,98	91,61	71	98	32	-	25	7		
PBD 24 H 100	4	1610	42	97,02	95,65	71	104	32	-	25	7		
PBD 25 H 100	4	1610	42	101,06	99,69	78	104	32	-	25	7		
PBD 26 H 100	4	1610	42	105,11	103,74	78	108	32	-	25	7		
PBD 27 H 100	4	1610	42	109,15	107,78	86	113	32	-	25	7		
PBD 28 H 100	4	1610	42	113,19	111,92	86	118	32	-	25	7		
PBD 29 H 100	4	1610	42	117,23	115,86	95	121	32	-	25	7		
PBD 30 H 100	4	1610	42	121,28	119,91	95	129	32	-	25	7		
PBD 32 H 100	8	1610	42	129,36	127,99	110	137	32	82	25	7		
PBD 33 H 100	8	1610	42	133,40	132,03	112	137	32	82	25	7		
PBD 34 H 100	8	1610	42	137,45	136,08	112	142	32	82	25	7		
PBD 35 H 100	8	1610	42	141,49	140,12	120	145	32	82	25	7		
PBD 36 H 100	8	1610	42	145,53	144,16	120	151	32	82	25	7		
PBD 38 H 100	8	1610	42	153,62	152,25	136	158	32	82	25	7		
PBD 40 H 100	8	1610	42	161,70	160,33	136	168	32	82	25	7		
PBD 44 H 100	7	2012	50	177,87	176,50	162	191	32	110	32	-		
PBD 45 H 100	7	2012	50	181,91	180,54	162	189	32	110	32	-		
PBD 48 H 100	7	2012	50	194,04	192,67	168	199	32	110	32	-		
PBD 49 H 100	12	2012	50	198,08	196,71	172	-	34	110	32	1		
PBD 50 H 100	12	2012	50	202,13	200,76	172	-	34	110	32	1		
PBD 52 H 100	12	2012	50	210,21	208,84	185	-	34	110	32	1		
PBD 60 H 100	12	2012	50	242,55	241,18	217	-	34	110	32	1		
PBD 70 H 100	15	2012	50	282,98	281,61	264	-	34	110	32	1		
PBD 72 H 100	15	2012	50	291,06	289,69	264	-	34	110	32	1		
PBD 82 H 100	15	2012	50	331,49	330,12	312	-	34	110	32	1		
PBD 84 H 100	15	2012	50	339,57	338,20	312	-	34	110	32	1		
PBD 94 H 100	13	2517	65	380,00	378,63	357	-	34	120	45	5,5		
PBD 96 H 100	13	2517	65	388,08	386,71	357	-	34	120	45	5,5		
PBD 106 H 100	13	2517	65	428,51	427,14	402	-	34	120	45	5,5		
PBD 116 H 100	13	2517	65	468,93	467,56	442	-	34	120	45	5,5		
PBD 118 H 100	13	2517	65	477,02	475,65	457	-	34	120	45	5,5		
PBD 120 H 100	13	2517	65	485,10	483,73	457	-	34	120	45	5,5		



PBD ... H 150

mm

code code Code Código	type type Typ tipo	bushing moyeu Spannbuchse bujie		R Ø	S Ø	U Ø	e Ø	W	H Ø	Y	Z	flange flasque Bord valona	material materiel Werkstoff material
		type type Typ tipo	bore alesage Bohrung bujie máx										
PBD 14 H 150	4	1108	28	56,60	55,23	37	62	45	-	22	23	with flanges avec flasques mit Borde con valona	cast iron fonte Grauguss fundición
PBD 15 H 150	4	1108	28	60,64	59,27	37	67	45	-	22	23		
PBD 16 H 150	4	1108	28	64,68	63,31	46	67	45	-	22	23		
PBD 17 H 150	4	1210	32	68,72	67,35	46	77	45	-	25	20		
PBD 18 H 150	4	1210	32	72,77	71,40	56	80	45	-	25	20		
PBD 19 H 150	4	1210	32	76,81	75,44	56	84	45	-	25	20		
PBD 20 H 150	4	1210	32	80,85	79,48	56	88	45	-	25	20		
PBD 21 H 150	4	1210	32	84,89	83,52	62	94	45	-	25	20		
PBD 22 H 150	4	1210	32	88,94	87,57	62	94	45	-	25	20		
PBD 23 H 150	4	1610	42	92,98	91,61	71	98	45	-	25	20		
PBD 24 H 150	4	1610	42	97,02	95,65	71	104	45	-	25	20		
PBD 25 H 150	4	1610	42	101,06	99,69	78	104	45	-	25	20		
PBD 26 H 150	4	1610	42	105,11	103,74	78	108	45	-	25	20		
PBD 27 H 150	4	1610	42	109,15	107,78	86	113	45	-	25	20		
PBD 28 H 150	4	1610	42	113,19	111,92	86	118	45	-	25	20		
PBD 29 H 150	4	1610	42	117,23	115,86	95	121	45	-	25	20		
PBD 30 H 150	4	1610	42	121,28	119,91	95	129	45	-	25	20		
PBD 32 H 150	8	1610	42	129,36	127,99	110	137	45	82	25	20		
PBD 33 H 150	8	1610	42	133,40	132,03	112	137	45	82	25	20		
PBD 34 H 150	8	1610	42	137,45	136,08	112	142	45	82	25	20		
PBD 35 H 150	8	1610	42	141,49	140,12	120	145	45	82	25	20		
PBD 36 H 150	8	1610	42	145,53	144,16	120	151	45	82	25	20		
PBD 38 H 150	8	1610	42	153,62	152,25	136	158	45	82	25	20		
PBD 40 H 150	8	1610	42	161,70	160,33	136	168	45	82	25	20		
PBD 44 H 150	8	2012	50	177,87	176,50	162	191	45	110	32	13		
PBD 45 H 150	8	2012	50	181,91	180,54	162	189	45	110	32	13		
PBD 48 H 150	8	2012	50	194,04	192,67	168	199	45	110	32	13		
PBD 49 H 150	12	2012	50	198,08	196,71	172	-	46	110	32	7		
PBD 50 H 150	12	2012	50	202,13	200,76	172	-	46	110	32	7		
PBD 52 H 150	12	2012	50	210,21	208,84	185	-	46	110	32	7		
PBD 60 H 150	15	2012	50	242,55	241,18	217	-	46	110	32	7		
PBD 70 H 150	15	2012	50	282,98	281,61	264	-	46	110	32	7		
PBD 72 H 150	15	2012	50	291,06	289,69	264	-	46	110	32	7		
PBD 82 H 150	15	2012	50	331,49	330,12	312	-	46	110	32	7		
PBD 84 H 150	15	2012	50	339,57	338,20	312	-	46	110	32	7		
PBD 94 H 150	15	2517	65	380,00	378,63	357	-	46	120	45	0,5		
PBD 96 H 150	15	2517	65	388,08	386,71	357	-	46	120	45	0,5		
PBD 106 H 150	15	2517	65	428,51	427,14	402	-	46	120	45	0,5		
PBD 116 H 150	15	2517	65	468,93	467,56	442	-	46	120	45	0,5		
PBD 118 H 150	15	2517	65	477,02	475,65	457	-	46	120	45	0,5		
PBD 120 H 150	15	2517	65	485,10	483,73	457	-	46	120	45	0,5		

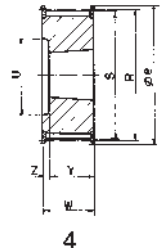

4

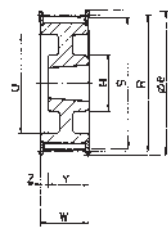

8

PBD ... H 200

mm

code code Code Código	type type Typ tipo	bushing moyeu Spannbuchse bujie		R Ø	S Ø	U Ø	e Ø	W	H Ø	Y	Z	flange flasque Bord valona	material materiel Werkstoff material
		type type Typ tipo	bore alesage Bohrung bujie máx										
PBD 16 H 200	4	1108	28	64,68	63,31	46	67	58	-	22	36	with flanges avec flasques mit Borde con valona	cast iron fonte Grauguss fundición
PBD 17 H 200	4	1210	32	68,72	67,35	52	77	58	-	25	33		
PBD 18 H 200	4	1210	32	72,77	71,40	52	80	58	-	25	33		
PBD 19 H 200	4	1610	42	76,81	75,44	56	84	58	-	25	33		
PBD 20 H 200	4	1610	42	80,85	79,48	56	88	58	-	25	33		
PBD 21 H 200	4	1610	42	84,89	83,52	62	94	58	-	25	33		
PBD 22 H 200	4	1610	42	88,94	87,57	62	94	58	-	25	33		
PBD 23 H 200	4	1610	42	92,98	91,61	71	98	58	-	25	33		
PBD 24 H 200	4	1610	42	97,02	95,65	71	104	58	-	25	33		
PBD 25 H 200	4	1610	42	101,06	99,69	78	104	58	-	25	33		
PBD 26 H 200	4	1610	42	105,11	103,74	78	108	58	-	25	33		
PBD 27 H 200	4	1610	42	109,15	107,78	86	113	58	-	25	33		
PBD 28 H 200	4	1610	42	113,19	111,92	86	118	58	-	25	33		
PBD 29 H 200	4	1610	42	117,23	115,86	95	121	58	-	25	33		
PBD 30 H 200	4	1610	42	121,28	119,91	95	129	58	-	25	33		
PBD 32 H 200	4	2012	50	129,36	127,99	110	137	58	-	32	26		
PBD 33 H 200	4	2012	50	133,40	132,03	112	137	58	-	32	26		
PBD 34 H 200	4	2012	50	137,45	136,08	112	142	58	-	32	26		
PBD 35 H 200	8	2012	50	141,49	140,12	120	145	58	102	32	26		
PBD 36 H 200	8	2012	50	145,53	144,16	120	151	58	102	32	26		
PBD 38 H 200	8	2012	50	153,62	152,25	136	158	58	110	32	26		
PBD 40 H 200	8	2012	50	161,70	160,33	136	168	58	110	32	26		
PBD 44 H 200	8	2012	50	177,87	176,50	162	191	58	110	32	26		
PBD 45 H 200	8	2012	50	181,91	180,54	162	189	58	110	32	26		
PBD 48 H 200	8	2517	65	194,04	192,67	168	199	58	120	45	13		
PBD 49 H 200	12	2517	65	198,08	196,71	172	-	60	120	45	7,5		
PBD 50 H 200	12	2517	65	202,13	200,76	172	-	60	120	45	7,5		
PBD 52 H 200	12	2517	65	210,21	208,84	185	-	60	120	45	7,5		
PBD 60 H 200	15	2517	65	242,55	241,18	217	-	60	120	45	7,5		
PBD 70 H 200	15	2517	65	282,98	281,61	264	-	60	120	45	7,5		
PBD 72 H 200	15	2517	65	291,06	289,69	264	-	60	120	45	7,5		
PBD 82 H 200	15	2517	65	331,49	330,12	312	-	60	120	45	7,5		
PBD 84 H 200	15	2517	65	339,57	338,20	312	-	60	120	45	7,5		
PBD 94 H 200	15	2517	65	380,00	378,63	357	-	60	120	45	7,5		
PBD 96 H 200	15	2517	65	388,08	386,71	357	-	60	120	45	7,5		
PBD 106 H 200	15	2517	65	428,51	427,14	402	-	60	120	45	7,5		
PBD 116 H 200	15	2517	65	468,93	467,56	442	-	60	120	45	7,5		
PBD 118 H 200	15	2517	65	477,02	475,65	457	-	60	120	45	7,5		
PBD 120 H 200	15	2517	65	485,10	483,73	457	-	60	120	45	7,5		

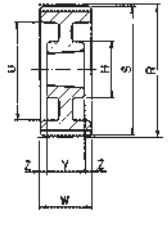

12

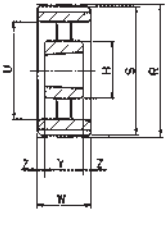

15



PBD ... H 300

mm

code code Code código	type type Typ tipo	bushing moyeu Spannbuchse bujie		R Ø	S Ø	U Ø	e Ø	W	H Ø	Y	Z	flange flasque Bord valona	material materiel Werkstoff material
		type type Typ tipo	bore alesage Bohrung bujie max										
PBD 19 H 300	3	1215	32	76,81	75,44	56	84	84	-	38	23	with flanges avec flasques mit Borde con valona	cast iron fonte Grauguss fundición
PBD 20 H 300	3	1615	42	80,85	79,48	56	88	84	-	38	23		
PBD 21 H 300	3	1615	42	84,89	83,52	62	94	84	-	38	23		
PBD 22 H 300	3	1615	42	88,94	87,57	62	94	84	-	38	23		
PBD 23 H 300	3	1615	42	92,98	91,61	71	98	84	-	38	23		
PBD 24 H 300	3	1615	42	97,02	95,65	71	104	84	-	38	23		
PBD 25 H 300	3	1615	42	101,06	99,69	78	104	84	-	38	23		
PBD 26 H 300	3	1615	42	105,11	103,74	78	108	84	-	38	23		
PBD 27 H 300	3	2012	50	109,15	107,78	86	113	84	-	32	26		
PBD 28 H 300	3	2012	50	113,19	111,92	86	118	84	-	32	26		
PBD 29 H 300	3	2012	50	117,23	115,86	95	121	84	-	32	26		
PBD 30 H 300	3	2012	50	121,28	119,91	95	129	84	-	32	26		
PBD 32 H 300	3	2517	65	129,36	127,99	110	137	84	-	45	19,5		
PBD 33 H 300	3	2517	65	133,40	132,03	112	137	84	-	45	19,5		
PBD 34 H 300	3	2517	65	137,45	136,08	112	142	84	-	45	19,5		
PBD 35 H 300	3	2517	65	141,49	140,12	120	145	84	-	45	19,5		
PBD 36 H 300	3	2517	65	145,53	144,16	120	151	84	-	45	19,5		
PBD 38 H 300	5	2517	65	153,62	152,25	136	158	84	120	45	19,5		
PBD 40 H 300	5	2517	65	161,70	160,33	136	168	84	120	45	19,5		
PBD 44 H 300	5	2517	65	177,87	176,50	162	191	86	120	45	20,5		
PBD 45 H 300	5	2517	65	181,91	180,54	162	189	86	120	45	20,5		
PBD 48 H 300	5	2517	65	194,04	192,67	168	199	86	120	45	20,5		
PBD 49 H 300	12	2517	65	198,08	196,71	172	-	86	120	45	20,5		
PBD 50 H 300	12	2517	65	202,13	200,76	172	-	86	120	45	20,5		
PBD 52 H 300	12	2517	65	210,21	208,84	185	-	86	120	45	20,5		
PBD 60 H 300	15	2517	65	242,55	241,18	217	-	86	120	45	20,5		
PBD 70 H 300	15	2517	65	282,98	281,61	264	-	86	120	45	20,5		
PBD 72 H 300	15	2517	65	291,06	289,69	264	-	86	120	45	20,5		
PBD 82 H 300	15	2517	65	331,49	330,12	312	-	86	120	45	20,5		
PBD 84 H 300	15	2517	65	339,57	338,20	312	-	86	120	45	20,5		
PBD 94 H 300	15	3030	75	380,00	378,63	357	-	86	146	76	5		
PBD 96 H 300	15	3030	75	388,08	386,71	357	-	86	146	76	5		
PBD 106 H 300	15	3030	75	428,51	427,14	402	-	86	146	76	5		
PBD 116 H 300	15	3030	75	468,93	467,56	442	-	86	146	76	5		
PBD 118 H 300	15	3030	75	477,02	475,65	457	-	86	146	76	5		
PBD 120 H 300	15	3030	75	485,10	483,73	457	-	86	146	76	5		

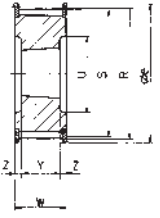

3

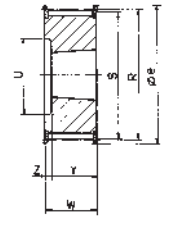

4

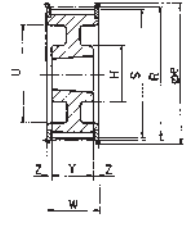

5

PBD ... XH 200

mm

code code Code código	type type Typ tipo	bushing moyeu Spannbuchse bujie		R Ø	S Ø	U Ø	e Ø	W	H Ø	Y	Z	flange flasque Bord valona	material materiel Werkstoff material
		type type Typ tipo	bore alesage Bohrung bujie max										
PBD 18 XH 200	4	2517	65	127,34	124,55	95	134	64	-	45	19	with flanges avec flasques mit Borde con valona	cast iron fonte Grauguss fundición
PBD 19 XH 200	4	2517	65	134,41	131,62	101	142	64	-	45	19		
PBD 20 XH 200	4	2517	65	141,49	138,70	101	150	64	-	45	19		
PBD 21 XH 200	4	2517	65	148,56	145,77	115	158	64	-	45	19		
PBD 22 XH 200	4	2517	65	155,64	152,85	115	166	64	-	45	19		
PBD 24 XH 200	4	2517	65	169,79	167,00	129	177	64	-	45	19		
PBD 25 XH 200	4	2517	65	176,86	174,07	143	186	64	-	45	19		
PBD 26 XH 200	4	2517	65	183,94	171,15	143	191	64	-	45	19		
PBD 27 XH 200	5	2517	65	191,01	188,22	157	200	64	120	45	9,5		
PBD 28 XH 200	5	2517	65	198,08	195,29	157	199	64	120	45	9,5		
PBD 30 XH 200	5	2517	65	212,23	209,44	180	216	64	120	45	9,5		
PBD 32 XH 200	5	2517	65	226,38	223,59	195	232	64	120	45	9,5		
PBD 34 XH 200	5	2517	65	240,53	237,74	208	261	64	120	45	9,5		
PBD 38 XH 200	5	2517	65	268,83	266,03	234	274	64	120	45	9,5		
PBD 40 XH 200	5	3020	75	282,98	280,19	242	288	64	146	51	6,5		
PBD 46 XH 200	15	3020	75	325,42	322,63	285	-	64	146	51	6,5		
PBD 48 XH 200	15	3020	75	339,57	336,78	299	-	64	146	51	6,5		
PBD 58 XH 200	15	3020	75	410,32	407,52	370	-	64	146	51	6,5		
PBD 60 XH 200	13	3535	90	424,47	421,68	384	-	64	178	89	12,5		
PBD 70 XH 200	13	3535	90	495,21	492,42	455	-	64	178	89	12,5		
PBD 72 XH 200	13	3535	90	509,36	506,57	469	-	64	178	89	12,5		
PBD 78 XH 200	13	3535	90	551,80	549,01	511	-	64	178	89	12,5		
PBD 80 XH 200	13	3535	90	565,95	563,16	525	-	64	178	89	12,5		
PBD 82 XH 200	13	3535	90	580,10	577,31	539	-	64	178	89	12,5		
PBD 84 XH 200	13	3535	90	594,25	591,46	554	-	64	178	89	12,5		

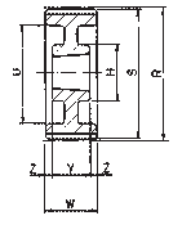

12

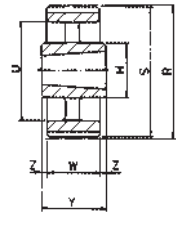

13

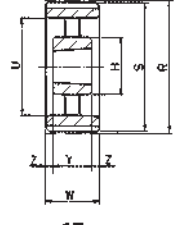

15



PBD ... XH 300

mm

code code Code código	type type Typ tipo	bushing moyeu Spannbuchse bujie		R Ø	S Ø	U Ø	e Ø	W	H Ø	Y	Z	flange flasque Bord valona	material materiel Werkstoff material
		type type Typ tipo	bore alesage Bohrung bujie máx										
PBD 18 XH 300	4	2517	65	127,34	124,55	95	134	90	-	45	45	with flanges avec flasques mit Borde con valona	cast iron fonte Grauguss fundición
PBD 19 XH 300	4	2517	65	134,41	131,62	95	142	90	-	45	45		
PBD 20 XH 300	4	2517	65	141,49	138,70	101	150	90	-	45	45		
PBD 21 XH 300	4	2517	65	148,56	145,77	115	158	90	-	45	45		
PBD 22 XH 300	4	2517	65	155,64	152,85	115	166	90	-	45	45		
PBD 24 XH 300	4	2517	65	169,79	167,00	129	177	90	-	45	45		
PBD 25 XH 300	4	2517	65	176,86	174,07	143	186	90	-	45	45		
PBD 26 XH 300	4	2517	65	183,94	171,15	143	191	90	-	45	45		
PBD 27 XH 300	8	3020	75	191,01	188,22	157	200	90	146	51	39		
PBD 28 XH 300	8	3020	75	198,08	195,29	157	199	90	146	51	39		
PBD 30 XH 300	8	3020	75	212,23	209,44	172	216	90	146	51	39		
PBD 32 XH 300	8	3020	75	226,38	223,59	186	232	90	146	51	39		
PBD 34 XH 300	8	3020	75	240,53	237,74	200	261	90	146	51	39		
PBD 38 XH 300	8	3020	75	268,83	266,03	228	274	90	146	51	39		
PBD 40 XH 300	5	3020	75	282,98	280,19	245	288	90	146	51	19,5		
PBD 46 XH 300	12	3020	75	325,42	322,63	285	-	90	146	51	19,5		
PBD 48 XH 300	12	3020	75	339,57	336,78	299	-	90	146	51	19,5		
PBD 58 XH 300	12	3535	90	410,32	407,52	370	-	90	178	89	0,5		
PBD 60 XH 300	12	3535	90	424,47	421,68	384	-	90	178	89	0,5		
PBD 70 XH 300	15	3535	90	495,21	492,42	455	-	90	178	89	0,5		
PBD 72 XH 300	15	3535	90	509,36	506,57	469	-	90	178	89	0,5		
PBD 78 XH 300	15	3535	90	551,80	549,01	511	-	90	178	89	0,5		
PBD 80 XH 300	15	3535	90	565,95	563,16	525	-	90	178	89	0,5		
PBD 82 XH 300	15	3535	90	580,10	577,31	539	-	90	178	89	0,5		
PBD 84 XH 300	13	4040	100	594,25	591,46	554	-	90	215	102	6		

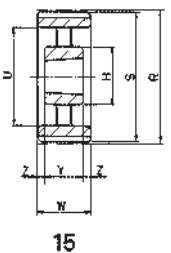
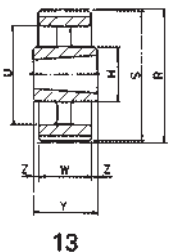
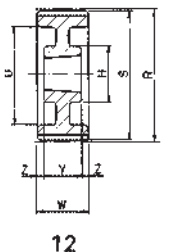
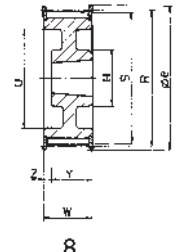
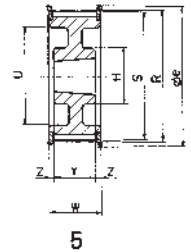
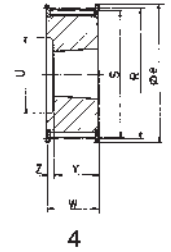

PBD ... XH 400

mm

code code Code código	type type Typ tipo	bushing moyeu Spannbuchse bujie		R Ø	S Ø	U Ø	e Ø	W	H Ø	Y	Z	flange flasque Bord valona	material materiel Werkstoff material
		type type Typ tipo	bore alesage Bohrung bujie máx										
PBD 18 XH 400	4	2517	65	127,34	124,55	95	134	119	-	45	74	with flanges avec flasques mit Borde con valona	cast iron fonte Grauguss fundición
PBD 19 XH 400	4	2517	65	134,41	131,62	95	142	119	-	45	74		
PBD 20 XH 400	4	2517	65	141,49	138,70	101	150	119	-	45	74		
PBD 21 XH 400	4	2517	65	148,56	145,77	115	158	119	-	45	74		
PBD 22 XH 400	4	2517	65	155,64	152,85	115	166	119	-	45	74		
PBD 24 XH 400	4	3020	75	169,79	167,00	129	177	119	-	51	68		
PBD 25 XH 400	4	3020	75	176,86	174,07	143	186	119	-	51	68		
PBD 26 XH 400	4	3020	75	183,94	171,15	143	191	119	-	51	68		
PBD 27 XH 400	4	3020	75	191,01	188,22	157	200	119	-	51	68		
PBD 28 XH 400	4	3020	75	198,08	195,29	157	199	119	-	51	68		
PBD 30 XH 400	8	3020	75	212,23	209,44	180	216	119	146	51	68		
PBD 32 XH 400	8	3020	75	226,38	223,59	195	232	119	146	51	68		
PBD 34 XH 400	8	3020	75	240,53	237,74	208	261	119	146	51	68		
PBD 38 XH 400	8	3020	75	268,83	266,03	234	274	119	146	51	68		
PBD 40 XH 400	5	3535	90	282,98	280,19	242	288	119	178	89	15		
PBD 46 XH 400	12	3535	90	325,42	322,63	285	-	119	178	89	15		
PBD 48 XH 400	12	3535	90	339,57	336,78	299	-	119	178	89	15		
PBD 58 XH 400	15	3535	90	410,32	407,52	370	-	119	178	89	51		
PBD 60 XH 400	15	4040	100	424,47	421,68	384	-	119	215	102	8,5		
PBD 70 XH 400	15	4040	100	495,21	492,42	455	-	119	215	102	8,5		
PBD 72 XH 400	15	4040	100	509,36	506,57	469	-	119	215	102	8,5		
PBD 78 XH 400	15	4040	100	551,80	549,01	511	-	119	215	102	8,5		
PBD 80 XH 400	15	4040	100	565,95	563,16	525	-	119	90	102	8,5		
PBD 82 XH 400	15	4040	100	580,10	577,31	539	-	119	90	102	8,5		
PBD 84 XH 400	15	4040	100	594,25	591,46	554	-	119	90	102	8,5		

«EXPORT» STANDARD TIMING PULLEYS
 «EXPORT» POULIES DENTEES
 «EXPORT» STANDARD-ZAHNSCHEIBEN
 «EXPORT» POLEAS DENTADAS

PDE ... XL 037

code code Code código	type type Typ tipo	type type Typ tipo	teeth dents Zähne dientes	R Ø	S Ø	e Ø	Y	Z	U	H Ø	W	d Ø	(Mx)	flange flasque Bord valona	material materiel Werkstoff material
PDE 10 XL 037	1	6F	10	16,17	15,66	20	19,8	5,5	-	9,5	14,3	4	M3	with flanges avec flasques mit Borde con valona	steel acier Stahl acero
PDE 11 XL 037	1	6F	11	17,79	17,28	20	19,8	5,5	-	11,1	14,3	4	M3		
PDE 12 XL 037	1	6F	12	19,40	18,89	24	19,8	5,5	-	12,7	14,3	4	M3		
PDE 14 XL 037	1	6F	14	22,64	22,16	27	19,8	5,5	-	14,3	14,3	6	M4		
PDE 15 XL 037	1	6F	15	24,25	23,74	27	19,8	5,5	-	15,9	14,3	6	M4		
PDE 16 XL 037	1	6F	16	25,87	25,36	30	19,8	5,5	-	17,5	14,3	6	M4		
PDE 18 XL 037	1	6F	18	29,11	28,60	33	19,8	5,5	-	20,6	14,3	6	M4		
PDE 20 XL 037	1	6F	20	32,34	31,83	36	22,2	7,9	-	23,8	14,3	6	M4		
PDE 21 XL 037	1	6F	21	33,96	33,45	40	22,2	7,9	-	23,8	14,3	6	M4		
PDE 22 XL 037	1	6F	22	35,57	35,06	40	22,2	7,9	-	25,4	14,3	6	M4		
PDE 24 XL 037	1	6F	24	38,81	38,30	46	22,2	7,9	-	27,0	14,3	6	M4		
PDE 26 XL 037	1	6F	26	42,03	41,53	46	22,2	7,9	-	30,0	14,3	6	M4		
PDE 28 XL 037	1	6F	28	45,28	44,77	50	22,2	7,9	-	30,2	14,3	6	M4		
PDE 30 XL 037	1	6F	30	49,51	48,00	55	22,2	7,9	-	34,9	14,3	6	M4		
PDE 32 XL 037	2	6	32	51,74	51,23	-	25,4	11,1	-	38,0	14,3	8	M4		
PDE 36 XL 037	2	6	36	58,21	57,70	-	25,4	11,1	-	38,0	14,3	8	M4		
PDE 40 XL 037	2	6	40	64,68	64,17	-	25,4	11,1	-	38,0	14,3	8	M4		
PDE 42 XL 037	4	6W	42	67,91	67,40	-	25,4	11,1	-	38,0	14,3	8	M4		
PDE 44 XL 037	4	6W	44	71,15	70,64	-	25,4	11,1	-	38,0	14,3	8	M4		
PDE 48 XL 037	4	6W	48	77,62	77,11	-	25,4	11,1	-	38,0	14,3	8	M4		
PDE 60 XL 037	7	6A	60	97,02	96,51	-	25,4	11,1	-	38,0	14,3	8	M4		
PDE 72 XL 037	7	6A	72	116,43	115,92	-	25,4	11,1	-	38,0	14,3	8	M4		

(Mx) set-screws - vis blocage - Stift-Schrauben - yornillos de bloqueo

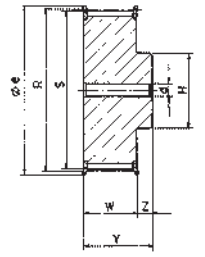

1

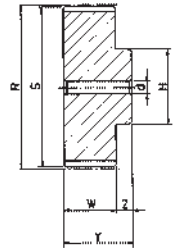

2

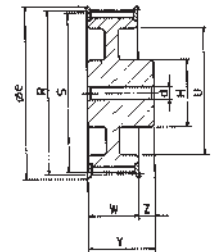

3

PDE ... L 050

code code Code código	type type Typ tipo	type type Typ tipo	teeth dents Zähne dientes	R Ø	S Ø	e Ø	Y	Z	U Ø	H Ø	W	E	d Ø	flange flasque Bord valona	material materiel Werkstoff material
PDE 10 L 050	1	6F	10	30,32	29,56	33	26,0	7,0	-	22,0	19,0	-	6	with flanges avec flasques mit Borde con valona	steel acier Stahl acero
PDE 12 L 050	1	6F	12	36,38	35,62	40	26,0	7,0	-	28,0	19,0	-	6		
PDE 13 L 050	1	6F	13	39,41	38,65	47	26,0	7,0	-	30,0	19,0	-	6		
PDE 14 L 050	1	6F	14	42,45	41,69	46	26,0	7,0	-	33,0	19,0	-	6		
PDE 15 L 050	1	6F	15	45,48	44,72	50	26,0	7,0	-	36,0	19,0	-	8		
PDE 16 L 050	1	6F	16	48,51	47,75	55	26,0	7,0	-	38,0	19,0	-	8		
PDE 17 L 050	1	6F	17	51,54	50,78	55	26,0	7,0	-	40,0	19,0	-	10		
PDE 18 L 050	1	6F	18	54,57	53,81	62	26,0	7,0	-	40,0	19,0	-	10		
PDE 19 L 050	1	6F	19	57,61	56,84	62	26,0	7,0	-	40,0	19,0	-	10		
PDE 20 L 050	1	6F	20	60,64	59,88	67	26,0	7,0	-	46,0	19,0	-	10		
PDE 21 L 050	1	6F	21	63,67	62,91	67	26,0	7,0	-	46,0	19,0	-	10		
PDE 22 L 050	1	6F	22	66,70	65,94	73	26,0	7,0	-	50,0	19,0	-	10		
PDE 24 L 050	1	6F	26	72,77	72,01	80	26,0	7,0	-	50,0	19,0	-	12		
PDE 26 L 050	1	6F	26	78,83	78,07	88	26,0	7,0	-	50,0	19,0	-	12		
PDE 28 L 050	1	6F	28	84,89	84,13	94	26,0	7,0	-	50,0	19,0	-	12		
PDE 30 L 050	1	6F	30	90,96	90,20	98	26,0	7,0	-	50,0	19,0	-	12		
PDE 32 L 050	1	6F	32	97,02	96,26	100	26,0	7,0	-	50,0	19,0	-	12		
PDE 36 L 050	3	6WF	36	109,15	108,39	113	26,0	7,0	85,0	50,0	19,0	-	12		
PDE 40 L 050	3	6WF	40	121,28	120,52	129	26,0	7,0	101,0	50,0	19,0	-	12		
PDE 44 L 050	6	6AF	44	133,40	132,64	142	26,0	7,0	110,0	50,0	19,0	-	12		
PDE 48 L 050	6	6AF	48	145,53	144,77	151	26,0	7,0	123,0	50,0	19,0	-	12		
PDE 50 L 050	7	6A	50	151,60	150,83	-	28,0	9,0	159,0	50,0	19,0	-	15		
PDE 72 L 050	7	6A	72	218,30	217,54	-	28,0	9,0	195,0	50,0	19,0	-	15		
PDE 84 L 050	7	6A	84	254,68	253,92	-	28,0	9,0	228,0	50,0	19,0	-	15		
														without flanges sans flasques ohne Borde sin valona	cast iron fonte Grauguss fundición

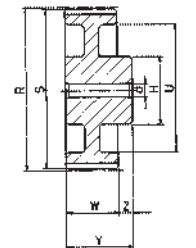

4

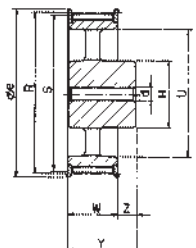

6

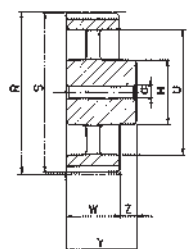

7



PDE ... L 075

mm

code code Code código	type type Typ tipo	type type Typ tipo	teeth dents Zähne dientes	R Ø	S Ø	e Ø	Y	Z	U Ø	H Ø	W	E	d Ø	flange flasque Bord valona	material materiel Werkstoff material
PDE 12 L 075	1	6F	12	36,38	35,62	40	32,0	7,0	-	28,0	25,0	-	8	with flanges avec flasques mit Borde con valona	steel acier Stahl acero
PDE 13 L 075	1	6F	13	39,41	38,65	47	32,0	7,0	-	30,0	25,0	-	8		
PDE 14 L 075	1	6F	14	42,45	41,69	46	32,0	7,0	-	33,0	25,0	-	8		
PDE 15 L 075	1	6F	15	45,48	44,72	50	32,0	7,0	-	36,0	25,0	-	8		
PDE 16 L 075	1	6F	16	48,51	47,75	55	32,0	7,0	-	38,0	25,0	-	8		
PDE 17 L 075	1	6F	17	51,54	50,78	55	32,0	7,0	-	40,0	25,0	-	10		
PDE 18 L 075	1	6F	18	54,57	53,81	62	32,0	7,0	-	40,0	25,0	-	10		
PDE 19 L 075	1	6F	19	57,61	56,84	62	32,0	7,0	-	40,0	25,0	-	10		
PDE 20 L 075	1	6F	20	60,64	59,88	67	32,0	7,0	-	46,0	25,0	-	10		
PDE 21 L 075	1	6F	21	63,67	62,91	67	32,0	7,0	-	46,0	25,0	-	10		
PDE 22 L 075	1	6F	22	66,70	65,94	73	32,0	7,0	-	50,0	25,0	-	10		
PDE 24 L 075	1	6F	26	72,77	72,01	80	32,0	7,0	-	50,0	25,0	-	12		
PDE 26 L 075	1	6F	26	78,83	78,07	88	32,0	7,0	-	50,0	25,0	-	12		
PDE 28 L 075	1	6F	28	84,89	84,13	94	32,0	7,0	-	50,0	25,0	-	12		
PDE 30 L 075	1	6F	30	90,96	90,20	98	32,0	7,0	-	50,0	25,0	-	12		
PDE 32 L 075	1	6F	32	97,02	96,26	100	32,0	7,0	-	50,0	25,0	-	12		
PDE 36 L 075	3	6WF	36	109,15	108,39	113	32,0	7,0	85,0	55,0	25,0	-	12		
PDE 40 L 075	3	6WF	40	121,28	120,52	129	32,0	7,0	101,0	60,0	25,0	-	12		
PDE 44 L 075	6	6AF	44	133,40	132,64	142	32,0	7,0	110,0	60,0	25,0	-	12		
PDE 48 L 075	6	6AF	48	145,53	144,77	151	32,0	7,0	123,0	60,0	25,0	-	12		
PDE 60 L 075	7	6A	60	181,91	181,15	-	35,0	7,0	159,0	60,0	26,0	-	15		
PDE 72 L 075	7	6A	72	218,30	217,54	-	35,0	7,0	195,0	60,0	26,0	-	15		
PDE 84 L 075	7	6A	84	254,68	253,92	-	35,0	7,0	228,0	60,0	26,0	-	15		

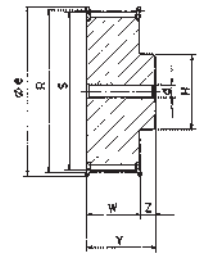

1

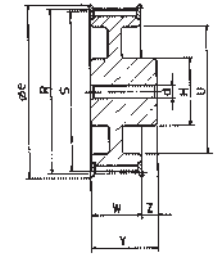

3

PDE ... L 100

mm

code code Code código	type type Typ tipo	type type Typ tipo	teeth dents Zähne dientes	R Ø	S Ø	e Ø	Y	Z	U Ø	H Ø	W	E	d Ø	flange flasque Bord valona	material materiel Werkstoff material
PDE 12 L 100	1	6F	12	36,38	35,62	40	38,0	7,0	-	28,0	31,0	-	8	with flanges avec flasques mit Borde con valona	steel acier Stahl acero
PDE 13 L 100	1	6F	13	39,41	38,65	47	38,0	7,0	-	30,0	31,0	-	8		
PDE 14 L 100	1	6F	14	42,45	41,69	46	38,0	7,0	-	33,0	31,0	-	8		
PDE 15 L 100	1	6F	15	45,48	44,72	50	38,0	7,0	-	36,0	31,0	-	8		
PDE 16 L 100	1	6F	16	48,51	47,75	55	38,0	7,0	-	38,0	31,0	-	8		
PDE 17 L 100	1	6F	17	51,54	50,78	55	38,0	7,0	-	40,0	31,0	-	10		
PDE 18 L 100	1	6F	18	54,57	53,81	62	38,0	7,0	-	40,0	31,0	-	10		
PDE 19 L 100	1	6F	19	57,61	56,84	62	38,0	7,0	-	40,0	31,0	-	10		
PDE 20 L 100	1	6F	20	60,64	59,88	67	38,0	7,0	-	46,0	31,0	-	10		
PDE 21 L 100	1	6F	21	63,67	62,91	67	38,0	7,0	-	46,0	31,0	-	10		
PDE 22 L 100	1	6F	22	66,70	65,94	73	38,0	7,0	-	50,0	31,0	-	10		
PDE 24 L 100	1	6F	26	72,77	72,01	80	38,0	7,0	-	50,0	31,0	-	12		
PDE 26 L 100	1	6F	26	78,83	78,07	88	38,0	7,0	-	50,0	31,0	-	12		
PDE 28 L 100	1	6F	28	84,89	84,13	94	38,0	7,0	-	50,0	31,0	-	12		
PDE 30 L 100	1	6F	30	90,96	90,20	98	38,0	7,0	-	50,0	31,0	-	12		
PDE 32 L 100	1	6F	32	97,02	96,26	100	38,0	7,0	-	50,0	31,0	-	12		
PDE 36 L 100	5	6WCF	36	109,15	108,39	113	32,0	6,0	85,0	55,0	32,0	6	12		
PDE 40 L 100	5	6WCF	40	121,28	120,52	129	32,0	6,0	101,0	60,0	32,0	6	12		
PDE 44 L 100	8	10AF	44	133,40	132,64	142	32,0	-	110,0	60,0	32,0	-	12		
PDE 48 L 100	8	10AF	48	145,53	144,77	151	32,0	-	123,0	60,0	32,0	-	12		
PDE 60 L 100	7	6A	60	181,91	181,15	-	35,0	3,0	159,0	60,0	32,0	-	15		
PDE 72 L 100	7	6A	72	218,30	217,54	-	35,0	3,0	195,0	60,0	32,0	-	15		
PDE 84 L 100	7	6A	84	254,68	253,92	-	35,0	3,0	228,0	60,0	32,0	-	15		

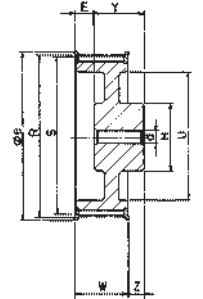

5

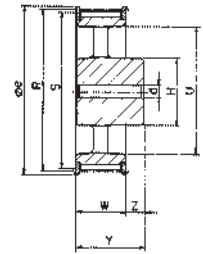

6

PDE ... H 100

mm

code code Code código	type type Typ tipo	type type Typ tipo	teeth dents Zähne dientes	R Ø	S Ø	e Ø	Y	Z	U Ø	H Ø	W	E	d Ø	flange flasque Bord valona	material materiel Werkstoff material
PDE 14 H 100	1	6F	14	56,60	55,23	62	41,0	10,0	-	40,0	31,0	-	10	with flanges avec flasques mit Borde con valona	steel acier Stahl acero
PDE 16 H 100	1	6F	16	64,68	63,31	67	41,0	10,0	-	46,0	31,0	-	10		
PDE 18 H 100	1	6F	18	72,77	71,40	80	41,0	10,0	-	54,0	31,0	-	12		
PDE 19 H 100	1	6F	19	76,81	75,44	84	41,0	10,0	-	58,0	31,0	-	12		
PDE 20 H 100	1	6F	20	80,85	79,48	88	41,0	10,0	-	62,0	31,0	-	12		
PDE 21 H 100	1	6F	21	84,89	83,52	94	41,0	10,0	-	67,0	31,0	-	12		
PDE 22 H 100	1	6F	22	88,94	87,57	94	41,0	10,0	-	70,0	31,0	-	12		
PDE 24 H 100	1	6F	24	97,02	95,65	104	41,0	10,0	-	75,0	31,0	-	12		
PDE 26 H 100	5	6WCF	26	105,11	103,74	108	32,0	8,0	83,0	55,0	32,0	8	15		
PDE 28 H 100	5	6WCF	28	113,19	111,92	118	32,0	8,0	92,0	60,0	32,0	8	15		
PDE 30 H 100	5	6WCF	30	121,28	119,91	129	32,0	8,0	101,0	60,0	32,0	8	15		
PDE 32 H 100	3	6WF	32	129,36	127,99	137	40,0	8,0	109,0	70,0	32,0	-	20		
PDE 36 H 100	3	6WF	36	145,53	144,16	151	40,0	8,0	123,0	80,0	32,0	-	20		
PDE 40 H 100	6	6AF	40	161,70	160,33	168	40,0	8,0	140,0	80,0	32,0	-	20		
PDE 44 H 100	6	6AF	44	177,87	176,50	191	40,0	8,0	149,0	80,0	32,0	-	20		
PDE 48 H 100	6	6AF	48	194,04	192,67	199	40,0	8,0	169,0	80,0	32,0	-	20		
PDE 60 H 100	7	6A	60	242,55	241,18	-	45,0	11,0	215,0	80,0	32,0	-	20		
PDE 72 H 100	7	6A	72	291,06	289,69	-	45,0	11,0	262,0	80,0	34,0	-	20		
PDE 84 H 100	7	6A	84	339,57	338,20	-	45,0	11,0	312,0	80,0	34,0	-	20		
PDE 96 H 100	7	6A	96	388,08	386,71	-	45,0	11,0	359,0	80,0	34,0	-	20		
PDE 120 H 100	7	6A	120	485,10	483,73	-	50,0	16,0	455,0	90,0	34,0	-	20		

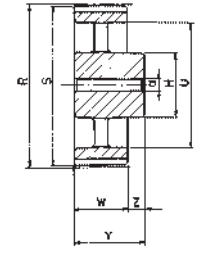

7

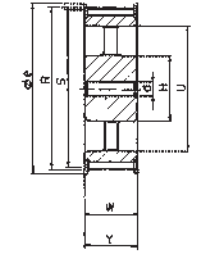

8

PDE ... H 150

code code Code código	type type Typ tipo	type type Typ tipo	teeth dents Zähne dientes	R Ø	S Ø	e Ø	Y	Z	U Ø	H Ø	W	E	d Ø	flange flasque Bord valona	material materiel Werkstoff material
PDE 14 H 150	1	6F	14	56,60	55,23	62	54,0	10,0	-	40,0	44,0	-	12	with flanges avec flasques mit Borde con valona	steel acier Stahl acero
PDE 16 H 150	1	6F	16	64,68	63,31	67	54,0	10,0	-	46,0	44,0	-	12		
PDE 18 H 150	1	6F	18	72,77	71,40	80	54,0	10,0	-	54,0	44,0	-	12		
PDE 19 H 150	1	6F	19	76,81	75,44	84	54,0	10,0	-	58,0	44,0	-	12		
PDE 20 H 150	1	6F	20	80,85	79,48	88	54,0	10,0	-	62,0	44,0	-	12		
PDE 21 H 150	1	6F	21	84,89	83,52	94	54,0	10,0	-	67,0	44,0	-	12		
PDE 22 H 150	1	6F	22	88,94	87,57	94	54,0	10,0	-	70,0	44,0	-	12		
PDE 24 H 150	1	6F	24	97,02	95,65	104	54,0	10,0	-	75,0	44,0	-	12		
PDE 26 H 150	5	6WCF	26	105,11	103,74	108	35,0	8,0	83,0	55,0	45,0	18	15		
PDE 28 H 150	5	6WCF	28	113,19	111,92	118	35,0	8,0	92,0	60,0	45,0	18	15		
PDE 30 H 150	5	6WCF	30	121,28	119,91	129	35,0	8,0	101,0	60,0	45,0	18	15	without flanges sous flasques ohne Borde sin valona	cast iron fonte Grauguss fundición
PDE 32 H 150	5	6WF	32	129,36	127,99	137	45,0	8,0	109,0	70,0	45,0	8	20		
PDE 36 H 150	5	6WF	36	145,53	144,16	151	45,0	8,0	123,0	80,0	45,0	8	20		
PDE 40 H 150	8	10AF	40	161,70	160,33	168	45,0	-	140,0	80,0	45,0	-	20		
PDE 44 H 150	8	10AF	44	177,87	176,50	191	45,0	-	149,0	80,0	45,0	-	20		
PDE 48 H 150	8	10AF	48	194,04	192,67	199	45,0	-	169,0	80,0	45,0	-	20		
PDE 60 H 150	9	10A	60	242,55	241,18	-	46,0	-	215,0	85,0	46,0	-	20		
PDE 72 H 150	9	10A	72	291,06	289,69	-	46,0	-	262,0	85,0	46,0	-	20		
PDE 84 H 150	9	10A	84	339,57	338,20	-	46,0	-	312,0	85,0	46,0	-	20		
PDE 96 H 150	9	10A	96	388,08	386,71	-	46,0	-	359,0	85,0	46,0	-	20		
PDE 120 H 150	7	6A	120	485,10	483,73	-	55,0	9,0	455,0	95,0	46,0	-	24		

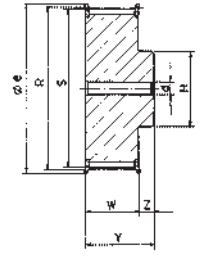

1

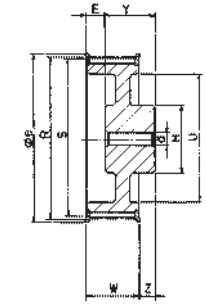

5

PDE ... H 200

code code Code código	type type Typ tipo	type type Typ tipo	teeth dents Zähne dientes	R Ø	S Ø	e Ø	Y	Z	U Ø	H Ø	W	E	d Ø	flange flasque Bord valona	material materiel Werkstoff material
PDE 14 H 200	1	6F	14	56,60	55,23	62	68,0	10,0	-	40,0	58,0	-	12	with flanges avec flasques mit Borde con valona	steel acier Stahl acero
PDE 16 H 200	1	6F	16	64,68	63,31	67	68,0	10,0	-	46,0	58,0	-	15		
PDE 18 H 200	1	6F	18	72,77	71,40	80	68,0	10,0	-	54,0	58,0	-	15		
PDE 19 H 200	1	6F	19	76,81	75,44	84	68,0	10,0	-	58,0	58,0	-	15		
PDE 20 H 200	1	6F	20	80,85	79,48	88	68,0	10,0	-	62,0	58,0	-	15		
PDE 21 H 200	1	6F	21	84,89	83,52	94	68,0	10,0	-	67,0	58,0	-	15		
PDE 22 H 200	1	6F	22	88,94	87,57	94	68,0	10,0	-	70,0	58,0	-	15		
PDE 24 H 200	1	6F	24	97,02	95,65	104	68,0	10,0	-	75,0	58,0	-	15		
PDE 26 H 200	5	6WCF	26	105,11	103,74	108	42,0	8,0	83,0	60,0	58,0	24	15		
PDE 28 H 200	5	6WCF	28	113,19	111,92	118	42,0	8,0	92,0	60,0	58,0	24	15		
PDE 30 H 200	5	6WCF	30	121,28	119,91	129	42,0	8,0	101,0	70,0	58,0	24	15	without flanges sous flasques ohne Borde sin valona	cast iron fonte Grauguss fundición
PDE 32 H 200	5	6WCF	32	129,36	127,99	137	47,0	8,0	109,0	70,0	58,0	19	20		
PDE 36 H 200	5	6WCF	36	145,53	144,16	151	47,0	8,0	123,0	80,0	58,0	19	20		
PDE 40 H 200	10	11AF	40	161,70	160,33	168	45,0	13,0	139,0	80,0	58,0	-	20		
PDE 44 H 200	10	11AF	44	177,87	176,50	191	45,0	13,0	149,0	80,0	58,0	-	20		
PDE 48 H 200	10	11AF	48	194,04	192,67	199	45,0	13,0	169,0	85,0	58,0	-	20		
PDE 60 H 200	11	11A	60	242,55	241,18	-	50,0	10,0	215,0	90,0	60,0	-	20		
PDE 72 H 200	11	11A	72	291,06	289,69	-	50,0	10,0	262,0	90,0	60,0	-	20		
PDE 84 H 200	11	11A	84	339,57	338,20	-	50,0	10,0	312,0	90,0	60,0	-	20		
PDE 96 H 200	11	11A	96	388,08	386,71	-	50,0	10,0	359,0	90,0	60,0	-	20		
PDE 120 H 200	9	10A	120	485,10	483,73	-	60,0	0,0	455,0	100,0	60,0	-	24		

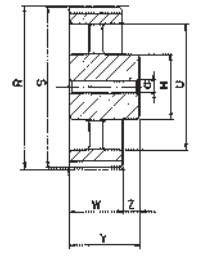

7

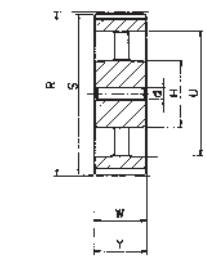

9

PDE ... H 300

code code Code código	type type Typ tipo	type type Typ tipo	teeth dents Zähne dientes	R Ø	S Ø	e Ø	Y	Z	U Ø	H Ø	W	E	d Ø	flange flasque Bord valona	material materiel Werkstoff material
PDE 16 H 300	1	6F	16	64,68	63,31	67	94,0	10,0	-	46,0	84,0	-	15	with flanges avec flasques mit Borde con valona	steel acier Stahl acero
PDE 18 H 300	1	6F	18	72,77	71,40	80	94,0	10,0	-	54,0	84,0	-	15		
PDE 19 H 300	1	6F	19	76,81	75,44	84	94,0	10,0	-	58,0	84,0	-	15		
PDE 20 H 300	1	6F	20	80,85	79,48	88	94,0	10,0	-	62,0	84,0	-	15		
PDE 21 H 300	1	6F	21	84,89	83,52	94	94,0	10,0	-	67,0	84,0	-	15		
PDE 22 H 300	1	6F	22	88,94	87,57	94	94,0	10,0	-	70,0	84,0	-	15		
PDE 24 H 300	1	6F	24	97,02	95,65	104	94,0	10,0	-	75,0	84,0	-	15		
PDE 26 H 300	5	6WCF	26	105,11	103,74	108	57,0	8,0	83,0	60,0	84,0	35	15		
PDE 28 H 300	5	6WCF	28	113,19	111,92	118	57,0	8,0	92,0	60,0	84,0	35	15		
PDE 30 H 300	5	6WCF	30	121,28	119,91	129	57,0	8,0	101,0	70,0	84,0	35	15		
PDE 32 H 300	5	6WCF	32	129,36	127,99	137	57,0	8,0	109,0	70,0	84,0	35	20		
PDE 36 H 300	5	6WCF	36	145,53	144,16	151	57,0	8,0	123,0	80,0	84,0	35	20		
PDE 40 H 300	10	11AF	40	161,70	160,33	168	55,0	29,0	139,0	80,0	84,0	-	20		
PDE 44 H 300	10	11AF	44	177,87	176,50	191	55,0	29,0	149,0	80,0	84,0	-	20		
PDE 48 H 300	10	11AF	48	194,04	192,67	199	55,0	29,0	169,0	85,0	84,0	-	20		
PDE 60 H 300	11	11A	60	242,55	241,18	-	55,0	31,0	215,0	90,0	86,0	-	20		
PDE 72 H 300	11	11A	72	291,06	289,69	-	55,0	31,0	262,0	90,0	86,0	-	20		
PDE 84 H 300	11	11A	84	339,57	338,20	-	55,0	31,0	312,0	90,0	86,0	-	20		
PDE 96 H 300	11	11A	96	388,08	386,71	-	55,0	31,0	359,0	90,0	86,0	-	20		
PDE 120 H 300	11	11A	120	485,10	483,73	-	65,0	21,0	455,0	100,0	86,0	-	24		

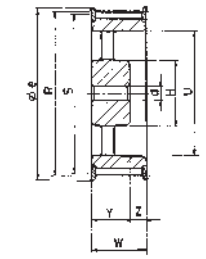

10

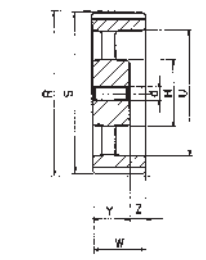

11



PDE ... XH 200 (*)

code code Code código	type type Typ tipo	type type Typ tipo	teeth dents Zähne dientes	R Ø	S Ø	e Ø	Y	Z	U Ø	H Ø	W	E	d Ø	flange flasque Bord valona	material materiel Werkstoff material
PDE 18 XH 200	12	6CF	18	127,34	124,55	134	62,0	18,0	-	85,0	62,0	18	20	with flanges avec flasques mit Borde con valona	cast iron fonte Grauguss fundición
PDE 20 XH 200	12	6CF	20	141,49	138,70	150	62,0	18,0	-	95,0	62,0	18	20		
PDE 22 XH 200	12	6CF	22	155,64	152,85	166	62,0	18,0	-	110,0	62,0	18	20		
PDE 24 XH 200	12	6CF	24	169,79	167,00	177	62,0	18,0	-	125,0	62,0	18	25		
PDE 26 XH 200	12	6CF	26	183,94	181,15	191	62,0	18,0	-	140,0	62,0	18	25		
PDE 28 XH 200	5	6WCF	28	198,08	195,29	199	62,0	18,0	156,0	120,0	62,0	18	25		
PDE 30 XH 200	5	6WCF	30	212,23	209,44	216	62,0	18,0	170,0	120,0	62,0	18	25		
PDE 32 XH 200	5	6WCF	32	226,38	223,59	232	62,0	18,0	184,0	130,0	62,0	18	25		
PDE 40 XH 200	5	6WCF	40	282,98	280,19	288	62,0	18,0	240,0	140,0	62,0	18	25		
PDE 48 XH 200	7	6A	48	339,57	336,78	-	80,0	15,0	297,0	150,0	65,0	-	30	without flanges sous flasques ohne Borde sin valona	cast iron fonte Grauguss fundición
PDE 60 XH 200	7	6A	60	424,47	421,68	-	80,0	15,0	382,0	150,0	65,0	-	30		
PDE 72 XH 200	7	6A	72	509,36	506,57	-	80,0	15,0	467,0	150,0	65,0	-	40		
PDE 84 XH 200	7	6A	84	594,25	591,46	-	80,0	15,0	552,0	160,0	65,0	-	40		
PDE 96 XH 200	7	6A	96	679,14	676,35	-	80,0	15,0	635,0	160,0	65,0	-	40		
PDE 120 XH 200	7	6A	120	848,93	846,14	-	80,0	15,0	805,0	160,0	65,0	-	40		

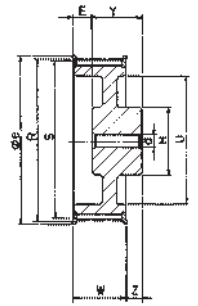

5

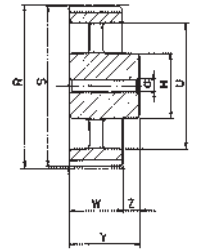

7

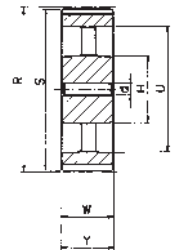

9

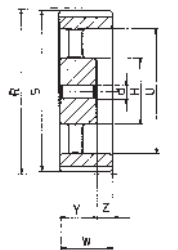

11

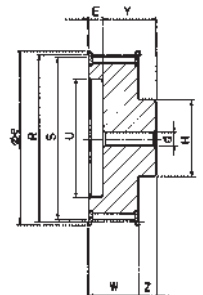

12

PDE ... XH 300 (*)

code code Code código	type type Typ tipo	type type Typ tipo	teeth dents Zähne dientes	R Ø	S Ø	e Ø	Y	Z	U Ø	H Ø	W	E	d Ø	flange flasque Bord valona	material materiel Werkstoff material
PDE 18 XH 300	12	6CF	18	127,34	124,55	134	70,0	16,0	-	85,0	89,0	35	20	with flanges avec flasques mit Borde con valona	cast iron fonte Grauguss fundición
PDE 20 XH 300	12	6CF	20	141,49	138,70	150	70,0	16,0	-	95,0	89,0	35	20		
PDE 22 XH 300	12	6CF	22	155,64	152,85	166	70,0	16,0	-	110,0	89,0	35	20		
PDE 24 XH 300	12	6CF	24	169,79	167,00	177	70,0	16,0	-	125,0	89,0	35	25		
PDE 26 XH 300	12	6CF	26	183,94	181,15	191	70,0	16,0	-	140,0	89,0	35	25		
PDE 28 XH 300	5	6WCF	28	198,08	195,29	199	70,0	16,0	156,0	120,0	89,0	35	25		
PDE 30 XH 300	5	6WCF	30	212,23	209,44	216	70,0	16,0	170,0	120,0	89,0	35	25		
PDE 32 XH 300	5	6WCF	32	226,38	223,59	232	70,0	16,0	184,0	130,0	89,0	35	25		
PDE 40 XH 300	5	6WCF	40	282,98	280,19	288	70,0	16,0	240,0	140,0	92,0	35	25		
PDE 48 XH 300	9	10A	48	339,57	336,78	-	92,0	-	297,0	150,0	92,0	-	30	without flanges sous flasques ohne Borde sin valona	cast iron fonte Grauguss fundición
PDE 60 XH 300	9	10A	60	424,47	421,68	-	92,0	-	382,0	150,0	92,0	-	30		
PDE 72 XH 300	9	10A	72	509,36	506,57	-	92,0	-	467,0	150,0	92,0	-	40		
PDE 84 XH 300	9	10A	84	594,25	591,46	-	92,0	-	552,0	160,0	92,0	-	40		
PDE 96 XH 300	9	10A	96	679,14	676,35	-	92,0	-	635,0	160,0	92,0	-	40		
PDE 120 XH 300	9	10A	120	848,93	846,14	-	92,0	-	805,0	160,0	92,0	-	40		

PDE ... XH 400 (*)

code code Code código	type type Typ tipo	type type Typ tipo	teeth dents Zähne dientes	R Ø	S Ø	e Ø	Y	Z	U Ø	H Ø	W	E	d Ø	flange flasque Bord valona	material materiel Werkstoff material
PDE 18 XH 400	12	6CF	18	127,34	124,55	134	85,0	16,0	-	85,0	116,0	47	20	with flanges avec flasques mit Borde con valona	cast iron fonte Grauguss fundición
PDE 20 XH 400	12	6CF	20	141,49	138,70	150	85,0	16,0	-	95,0	116,0	47	20		
PDE 22 XH 400	12	6CF	22	155,64	152,85	166	85,0	16,0	-	110,0	116,0	47	20		
PDE 24 XH 400	12	6CF	24	169,79	167,00	177	85,0	16,0	-	125,0	116,0	47	25		
PDE 26 XH 400	12	6CF	26	183,94	181,15	191	85,0	16,0	-	140,0	116,0	47	25		
PDE 28 XH 400	5	6WCF	28	198,08	195,29	199	85,0	16,0	156,0	120,0	116,0	47	25		
PDE 30 XH 400	5	6WCF	30	212,23	209,44	216	85,0	16,0	170,0	120,0	116,0	47	25		
PDE 32 XH 400	5	6WCF	32	226,38	223,59	232	85,0	16,0	184,0	130,0	116,0	47	25		
PDE 40 XH 400	5	6WCF	40	282,98	280,19	288	85,0	16,0	240,0	140,0	116,0	47	25		
PDE 48 XH 400	11	11A	48	339,57	336,78	-	92,0	27,0	297,0	150,0	119,0	-	30	without flanges sous flasques ohne Borde sin valona	cast iron fonte Grauguss fundición
PDE 60 XH 400	11	11A	60	424,47	421,68	-	92,0	27,0	382,0	150,0	119,0	-	30		
PDE 72 XH 400	11	11A	72	509,36	506,57	-	92,0	27,0	467,0	150,0	119,0	-	40		
PDE 84 XH 400	11	11A	84	594,25	591,46	-	92,0	27,0	552,0	160,0	119,0	-	40		
PDE 96 XH 400	11	11A	96	679,14	676,35	-	92,0	27,0	635,0	160,0	119,0	-	40		
PDE 120 XH 400	11	11A	120	848,93	846,14	-	92,0	27,0	805,0	160,0	119,0	-	40		

(*) Non stock pulleys. Stock pulleys XH pitch are shown at pages 22-23
 Poulies pas en stock. Pour poulies en stock pas XH voir pages 22-23
 Keine lager Scheiben, Lager Scheiben in Teilung XH erfolgen auf Seite 22-23
 No stock pleas. Poleas de stock paso XH, ver paginas 22-23.

STANDARD «SUPER TORQUE» TIMING PULLEYS
POULIES DENTEES «SUPER TORQUE» DE SERIE
STANDARD-ZAHNSCHEIBEN «SUPER TORQUE»
POLEAS DENTADAS «SUPER TORQUE» DE SERIE

Pitch - Pas
 Teilung - Paso **8 mm**

S 8 M-20

code code Code código	teeth dents Zähne dientes	type type Typ tipo	R mm	S mm	Øe mm	U mm	W mm	H mm	Y mm	Z mm	Ød mm	flange flasque Bord valona	material materiel Werkstoff material
18 S 8 M 20	18	1	45,84	44,46	50	-	28	32	38	10	-	with flanges avec flasques mit Borde con valona	steel acier Stahl acero
20 S 8 M 20	20	1	50,93	49,56	55	-	28	36	38	10	-		
22 S 8 M 20	22	1	56,02	54,65	62	-	28	43	38	10	-		
24 S 8 M 20	24	1	61,12	59,74	67	-	28	49	38	10	-		
26 S 8 M 20	26	1	66,21	64,84	73	-	28	50	38	10	-		
28 S 8 M 20	28	1	71,30	69,93	77	-	28	55	38	10	-		
30 S 8 M 20	30	1	76,39	75,02	84	-	28	60	38	10	-		
32 S 8 M 20	32	1	81,49	80,12	88	-	28	64	38	10	-		
34 S 8 M 20	34	1	86,58	85,21	94	-	28	70	38	10	-		
36 S 8 M 20	36	1	91,67	90,30	98	-	28	75	38	10	-		
38 S 8 M 20	38	1	96,77	95,39	104	-	28	80	38	10	-		
40 S 8 M 20	40	1	101,86	100,49	108	-	28	85	38	10	-		
44 S 8 M 20	44	1	112,05	110,67	121	-	28	96	38	10	-		
48 S 8 M 20	48	1	122,23	120,86	129	-	28	104	38	10	-		
56 S 8 M 20	56	2	142,60	141,23	149	117	28	80	38	10	-		
60 S 8 M 20	60	2	152,79	151,42	158	127	28	80	38	10	-		
64 S 8 M 20	64	2	162,97	161,60	168	137	28	80	38	10	-		
72 S 8 M 20	72	2	183,35	181,97	191	158	28	80	38	10	-		
80 S 8 M 20	80	6	203,72	202,35	-	179	28	90	38	10	-		
84 S 8 M 20	84	6	213,90	212,53	-	190	28	90	38	10	-		
90 S 8 M 20	90	6	229,18	227,81	-	204	28	90	38	10	-		
112 S 8 M 20	112	5	285,21	283,83	-	260	28	90	38	10	19		
144 S 8 M 20	144	5	366,69	365,32	-	342	28	90	38	10	19		
168 S 8 M 20	168	5	427,80	426,42	-	403	28	100	38	10	19		
192 S 8 M 20	192	5	488,92	487,54	-	465	28	100	38	10	19		
												without flanges sous flasques ohne Borde sin valona	cast iron fonte Grauguss fundición

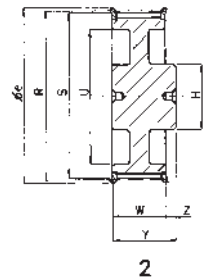
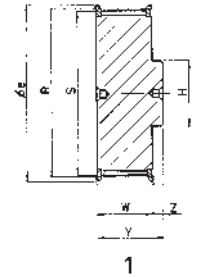

S 8 M-30

code code Code código	teeth dents Zähne dientes	type type Typ tipo	R mm	S mm	Øe mm	U mm	W mm	H mm	Y mm	Z mm	Ød mm	flange flasque Bord valona	material materiel Werkstoff material
18 S 8 M 30	18	1	45,84	44,46	50	-	38	32	48	10	-	with flanges avec flasques mit Borde con valona	steel acier Stahl acero
20 S 8 M 30	20	1	50,93	49,56	55	-	38	36	48	10	-		
22 S 8 M 30	22	1	56,02	54,65	62	-	38	43	48	10	-		
24 S 8 M 30	24	1	61,12	59,74	67	-	38	49	48	10	-		
26 S 8 M 30	26	1	66,21	64,84	73	-	38	50	48	10	-		
28 S 8 M 30	28	1	71,30	69,93	77	-	38	55	48	10	-		
30 S 8 M 30	30	1	76,39	75,02	84	-	38	60	48	10	-		
32 S 8 M 30	32	1	81,49	80,12	88	-	38	64	48	10	-		
34 S 8 M 30	34	1	86,58	85,21	94	-	38	70	48	10	-		
36 S 8 M 30	36	1	91,67	90,30	98	-	38	75	48	10	-		
38 S 8 M 30	38	1	96,77	95,39	104	-	38	80	48	10	-		
40 S 8 M 30	40	1	101,86	100,49	108	-	38	85	48	10	-		
44 S 8 M 30	44	1	112,05	110,67	121	-	38	96	48	10	-		
48 S 8 M 30	48	1	122,23	120,86	129	-	38	104	48	10	-		
56 S 8 M 30	56	2	142,60	141,23	149	117	38	90	48	10	-		
60 S 8 M 30	60	2	152,79	151,42	158	127	38	90	48	10	-		
64 S 8 M 30	64	2	162,97	161,60	168	137	38	90	48	10	-		
72 S 8 M 30	72	2	183,35	181,97	191	158	38	95	48	10	-		
80 S 8 M 30	80	6	203,72	202,35	-	179	38	100	48	10	-		
84 S 8 M 30	84	6	213,90	212,53	-	190	38	100	48	10	-		
90 S 8 M 30	90	6	229,18	227,81	-	204	38	100	48	10	-		
112 S 8 M 30	112	5	285,21	283,83	-	260	38	100	48	10	19		
144 S 8 M 30	144	5	366,69	365,32	-	342	38	100	48	10	19		
168 S 8 M 30	168	5	427,80	426,42	-	403	38	100	48	10	19		
192 S 8 M 30	192	5	488,92	487,54	-	465	38	100	48	10	19		
												without flanges sous flasques ohne Borde sin valona	cast iron fonte Grauguss fundición

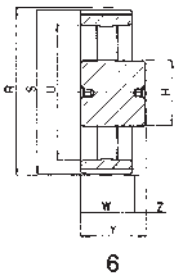
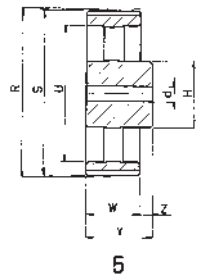

S 8 M-50

code code Code código	teeth dents Zähne dientes	type type Typ tipo	R mm	S mm	Øe mm	U mm	W mm	H mm	Y mm	Z mm	Ød mm	flange flasque Bord valona	material materiel Werkstoff material
18 S 8 M 50	18	1	45,84	44,46	50	-	60	32	70	10	-	with flanges avec flasques mit Borde con valona	steel acier Stahl acero
20 S 8 M 50	20	1	50,93	49,56	55	-	60	36	70	10	-		
22 S 8 M 50	22	1	56,02	54,65	62	-	60	43	70	10	-		
24 S 8 M 50	24	1	61,12	59,74	67	-	60	49	70	10	-		
26 S 8 M 50	26	1	66,21	64,84	73	-	60	50	70	10	-		
28 S 8 M 50	28	1	71,30	69,93	77	-	60	55	70	10	-		
30 S 8 M 50	30	1	76,39	75,02	84	-	60	60	70	10	-		
32 S 8 M 50	32	1	81,49	80,12	88	-	60	64	70	10	-		
34 S 8 M 50	34	1	86,58	85,21	94	-	60	70	70	10	-		
36 S 8 M 50	36	1	91,67	90,30	98	-	60	75	70	10	-		
38 S 8 M 50	38	1	96,77	95,39	104	-	60	80	70	10	-		
40 S 8 M 50	40	1	101,86	100,49	108	-	60	85	70	10	-		
44 S 8 M 50	44	1	112,05	110,67	121	-	60	96	70	10	-		
48 S 8 M 50	48	1	122,23	120,86	129	-	60	104	70	10	-		
56 S 8 M 50	56	8	142,60	141,23	149	117	60	90	60	-	-		
60 S 8 M 50	60	8	152,79	151,42	158	127	60	100	60	-	-		
64 S 8 M 50	64	8	162,97	161,60	168	137	60	100	60	-	-		
72 S 8 M 50	72	8	183,35	181,97	191	158	60	100	60	-	-		
80 S 8 M 50	80	8	203,72	202,35	-	179	60	110	60	-	-		
84 S 8 M 50	84	10	213,90	212,53	-	190	60	110	60	-	-		
90 S 8 M 50	90	10	229,18	227,81	-	204	60	110	60	-	-		
112 S 8 M 50	112	11	285,21	283,83	-	260	60	110	60	-	19		
144 S 8 M 50	144	11	366,69	365,32	-	342	60	110	60	-	19		
168 S 8 M 50	168	11	427,80	426,42	-	403	60	120	60	-	19		
192 S 8 M 50	192	11	488,92	487,54	-	465	60	130	60	-	19		

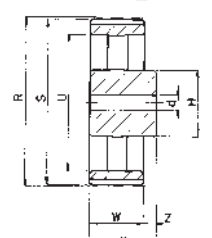
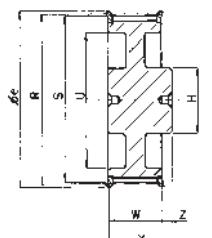
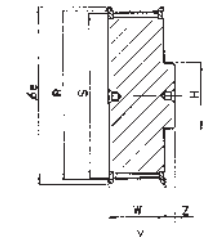

S 8 M-85

code code Code código	teeth dents Zähne dientes	type type Typ tipo	R mm	S mm	Øe mm	U mm	W mm	H mm	Y mm	Z mm	Ød mm	flange flasque Bord valona	material materiel Werkstoff material
22 S 8 M 85	22	1	56,02	54,65	62	-	95	43	105	10	-	with flanges avec flasques mit Borde con valona	steel acier Stahl acero
24 S 8 M 85	24	1	61,12	59,74	67	-	95	49	105	10	-		
26 S 8 M 85	26	1	66,21	64,84	73	-	95	50	105	10	-		
28 S 8 M 85	28	1	71,30	69,93	77	-	95	55	105	10	-		
30 S 8 M 85	30	1	76,39	75,02	84	-	95	60	105	10	-		
32 S 8 M 85	32	1	81,49	80,12	88	-	95	64	105	10	-		
34 S 8 M 85	34	1	86,58	85,21	94	-	95	70	105	10	-		
36 S 8 M 85	36	1	91,67	90,30	98	-	95	75	105	10	-		
38 S 8 M 85	38	1	96,77	95,39	104	-	95	80	105	10	-		
40 S 8 M 85	40	1	101,86	100,49	108	-	95	85	105	10	-		
44 S 8 M 85	44	1	112,05	110,67	121	-	95	96	105	10	-		
48 S 8 M 85	48	1	122,23	120,86	129	-	95	104	105	10	-		
56 S 8 M 85	56	1	142,60	141,23	149	-	95	107	105	10	-		
60 S 8 M 85	60	1	152,79	151,42	158	-	95	132	105	10	-		
64 S 8 M 85	64	8	162,97	161,60	168	137	95	100	95	-	-		
72 S 8 M 85	72	8	183,35	181,97	191	158	95	110	95	-	-		
80 S 8 M 85	80	9	203,72	202,35	-	179	95	110	95	-	-		
84 S 8 M 85	84	9	213,90	212,53	-	190	95	110	95	-	-		
90 S 8 M 85	90	10	229,18	227,81	-	204	95	110	95	-	-		
112 S 8 M 85	112	11	285,21	283,83	-	260	95	110	95	-	19		
144 S 8 M 85	144	11	366,69	365,32	-	342	95	120	95	-	19		
168 S 8 M 85	168	11	427,80	426,42	-	403	95	120	95	-	19		
192 S 8 M 85	192	11	488,92	487,54	-	465	95	130	95	-	19		

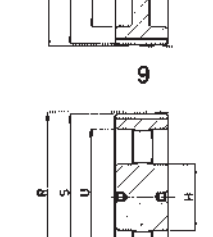
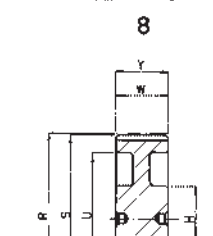
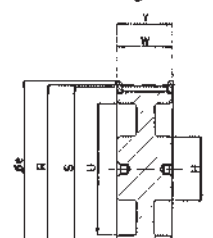

Pitch - Pas
Teilung - Paso

14 mm

S 14 M-40

code code Code código	teeth dents Zähne dientes	type type Typ tipo	R mm	S mm	Øe mm	U mm	W mm	H mm	Y mm	Z mm	Ød mm	flange flasque Bord valona	material materiel Werkstoff material
28 S 14 M 40	28	1	124,78	121,98	134	-	54	100	69	15	-	with flanges avec flasques mit Borde con valona	cast iron - fonte - Grauguss - fundición
29 S 14 M 40	29	1	129,23	126,44	134	-	54	107	69	15	-		
30 S 14 M 40	30	1	133,69	130,90	142	-	54	107	69	15	-		
32 S 14 M 40	32	1	142,60	139,81	150	-	54	114	69	15	-		
34 S 14 M 40	34	1	151,51	148,72	158	-	54	122	69	15	-		
36 S 14 M 40	36	1	160,43	157,63	166	-	54	128	69	15	-		
38 S 14 M 40	38	1	169,34	166,55	177	-	54	141	69	15	-		
40 S 14 M 40	40	1	178,25	175,46	186	-	54	148	69	15	-		
44 S 14 M 40	44	2	196,08	193,28	209	154	54	120	69	15	-		
48 S 14 M 40	48	2	213,90	211,11	216	172	54	135	69	15	-		
56 S 14 M 40	56	2	249,56	246,76	261	207	54	135	69	15	-		
60 S 14 M 40	60	2	267,38	264,59	274	225	54	135	69	15	-		
64 S 14 M 40	64	2	285,21	282,41	288	243	54	135	69	15	-		
72 S 14 M 40	72	5	320,86	318,06	-	279	54	135	69	15	19		
80 S 14 M 40	80	5	356,51	353,71	-	314	54	135	69	15	19		
84 S 14 M 40	84	5	374,33	371,54	-	332	54	135	69	15	19		
90 S 14 M 40	90	5	401,07	398,28	-	359	54	135	69	15	19		
112 S 14 M 40	112	5	499,11	496,32	-	457	54	135	69	15	19		
144 S 14 M 40	144	5	641,71	638,92	-	600	54	135	69	15	19		

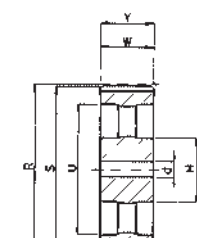
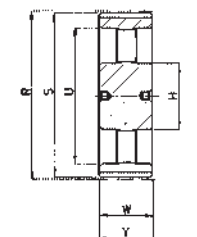

S 14 M-55

code code Code código	teeth dents Zähne dientes	type type Typ tipo	R mm	S mm	Øe mm	U mm	W mm	H mm	Y mm	Z mm	Ød mm	flange flasque Bord valona	material materiel Werkstoff material
28 S 14 M 55	28	1	124,78	121,98	134	-	70	100	85	15	-	with flanges avec flasques mit Borde con valona	cast iron - fonte - Grauguss - fundición
29 S 14 M 55	29	1	129,23	126,44	134	-	70	107	85	15	-		
30 S 14 M 55	30	1	133,69	130,90	142	-	70	107	85	15	-		
32 S 14 M 55	32	1	142,60	139,81	150	-	70	114	85	15	-		
34 S 14 M 55	34	1	151,51	148,72	158	-	70	122	85	15	-		
36 S 14 M 55	36	1	160,43	157,63	166	-	70	128	85	15	-		
38 S 14 M 55	38	1	169,34	166,55	177	-	70	141	85	15	-		
40 S 14 M 55	40	1	178,25	175,46	186	-	70	148	85	15	-		
44 S 14 M 55	44	2	196,08	193,28	209	154	70	120	85	15	-		
48 S 14 M 55	48	8	213,90	211,11	216	172	70	135	70	-	-		
56 S 14 M 55	56	8	249,56	246,76	261	207	70	135	70	-	-		
60 S 14 M 55	60	8	267,38	264,59	274	225	70	135	70	-	-		
64 S 14 M 55	64	8	285,21	282,41	288	243	70	135	70	-	-		
72 S 14 M 55	72	11	320,86	318,06	-	279	70	135	70	-	19		
80 S 14 M 55	80	11	356,51	353,71	-	314	70	135	70	-	19		
84 S 14 M 55	84	11	374,33	371,54	-	332	70	135	70	-	19		
90 S 14 M 55	90	11	401,07	398,28	-	359	70	135	70	-	19		
112 S 14 M 55	112	11	499,11	496,32	-	457	70	135	70	-	19		
144 S 14 M 55	144	11	641,71	638,92	-	600	70	135	70	-	19		

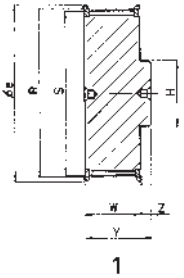

S 14 M-85

code code Code código	teeth dents Zähne dientes	type type Typ tipo	R mm	S mm	Øe mm	U mm	W mm	H mm	Y mm	Z mm	Ød mm	flange flasque Bord valona	material materiel Werkstoff material
28 S 14 M 85	28	1	124,78	121,98	134	-	102	100	117	15	-	with flanges avec flasques mit Borde con valona	cast iron - fonte - Grauguss - fundición
29 S 14 M 85	29	1	129,23	126,44	134	-	102	107	117	15	-		
30 S 14 M 85	30	1	133,69	130,90	142	-	102	107	117	15	-		
32 S 14 M 85	32	1	142,60	139,81	150	-	102	114	117	15	-		
34 S 14 M 85	34	1	151,51	148,72	158	-	102	122	117	15	-		
36 S 14 M 85	36	1	160,43	157,63	166	-	102	128	117	15	-		
38 S 14 M 85	38	1	169,34	166,55	177	-	102	141	117	15	-		
40 S 14 M 85	40	1	178,25	175,46	186	-	102	148	117	15	-		
44 S 14 M 85	44	1	196,08	193,28	209	-	102	169	117	15	-		
48 S 14 M 85	48	1	213,90	211,11	216	-	102	186	117	15	-		
56 S 14 M 85	56	8	249,56	246,76	261	207	102	150	102	-	-		
60 S 14 M 85	60	8	267,38	264,59	274	225	102	150	102	-	-		
64 S 14 M 85	64	8	285,21	282,41	288	243	102	150	102	-	-		
72 S 14 M 85	72	11	320,86	318,06	-	279	102	150	102	-	19		
80 S 14 M 85	80	11	356,51	353,71	-	314	102	150	102	-	19		
84 S 14 M 85	84	11	374,33	371,54	-	332	102	150	102	-	19		
90 S 14 M 85	90	11	401,07	398,28	-	359	102	150	102	-	19		
112 S 14 M 85	112	11	499,11	496,32	-	457	102	150	102	-	19		
144 S 14 M 85	144	11	641,71	638,92	-	600	102	150	102	-	19		

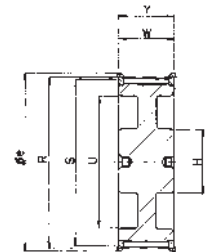
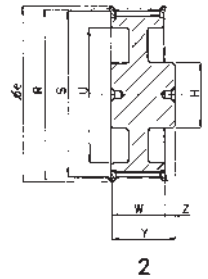

S 14 M-115

code code Code código	teeth dents Zähne dientes	type type Typ tipo	R mm	S mm	Øe mm	U mm	W mm	H mm	Y mm	Z mm	Ød mm	flange flasque Bord valona	material materiel Werkstoff material
28 S 14 M 115	28	1	124,78	121,98	134	-	133	100	148	15	-	with flanges avec flasques mit Borde con valona	cast iron - fonte - Grauguss - fundición
29 S 14 M 115	29	1	129,23	126,44	134	-	133	107	148	15	-		
30 S 14 M 115	30	1	133,69	130,90	142	-	133	107	148	15	-		
32 S 14 M 115	32	1	142,60	139,81	150	-	133	114	148	15	-		
34 S 14 M 115	34	1	151,51	148,72	158	-	133	122	148	15	-		
36 S 14 M 115	36	1	160,43	157,63	166	-	133	128	148	15	-		
38 S 14 M 115	38	1	169,34	166,55	177	-	133	141	148	15	-		
40 S 14 M 115	40	1	178,25	175,46	186	-	133	148	148	15	-		
44 S 14 M 115	44	1	196,08	193,28	209	-	133	169	148	15	-		
48 S 14 M 115	48	1	213,90	211,11	216	-	133	186	148	15	-		
56 S 14 M 115	56	2	249,56	246,76	261	207	133	150	133	-	-		
60 S 14 M 115	60	8	267,38	264,59	274	225	133	150	133	-	-		
64 S 14 M 115	64	8	285,21	282,41	288	243	133	150	133	-	-		
72 S 14 M 115	72	11	320,86	318,06	-	279	133	150	133	-	19		
80 S 14 M 115	80	11	356,51	353,71	-	314	133	150	133	-	19		
84 S 14 M 115	84	11	374,33	371,54	-	332	133	150	133	-	19		
90 S 14 M 115	90	11	401,07	398,28	-	359	133	150	133	-	19		
112 S 14 M 115	112	11	499,11	496,32	-	457	133	150	133	-	19		
144 S 14 M 115	144	11	641,71	638,92	-	600	133	150	133	-	19		

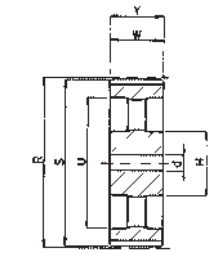

S 14 M-170

code code Code código	teeth dents Zähne dientes	type type Typ tipo	R mm	S mm	Øe mm	U mm	W mm	H mm	Y mm	Z mm	Ød mm	flange flasque Bord valona	material materiel Werkstoff material
28 S 14 M 170	28	1	124,78	121,98	134	-	187	100	202	15	-	with flanges avec flasques mit Borde con valona	cast iron - fonte - Grauguss - fundición
29 S 14 M 170	29	1	129,23	126,44	134	-	187	107	202	15	-		
30 S 14 M 170	30	1	133,69	130,90	142	-	187	107	202	15	-		
32 S 14 M 170	32	1	142,60	139,81	150	-	187	114	202	15	-		
34 S 14 M 170	34	1	151,51	148,72	158	-	187	122	202	15	-		
36 S 14 M 170	36	1	160,43	157,63	166	-	187	128	202	15	-		
38 S 14 M 170	38	1	169,34	166,55	177	-	187	141	202	15	-		
40 S 14 M 170	40	1	178,25	175,46	186	-	187	148	202	15	-		
44 S 14 M 170	44	1	196,08	193,28	209	-	187	169	202	15	-		
48 S 14 M 170	48	1	213,90	211,11	216	-	187	186	202	15	-		
56 S 14 M 170	56	2	249,56	246,76	261	207	187	160	202	15	-		
60 S 14 M 170	60	2	267,38	264,59	274	225	187	160	202	15	-		
64 S 14 M 170	64	2	285,21	282,41	288	243	187	180	202	15	-		
72 S 14 M 170	72	12	320,86	318,06	-	279	187	180	187	-	19		
80 S 14 M 170	80	12	356,51	353,71	-	314	187	180	187	-	19		
84 S 14 M 170	84	11	374,33	371,54	-	332	187	180	187	-	19		
90 S 14 M 170	90	11	401,07	398,28	-	359	187	180	187	-	19		
112 S 14 M 170	112	11	499,11	496,32	-	457	187	200	187	-	19		
144 S 14 M 170	144	11	641,71	638,92	-	600	187	220	187	-	19		

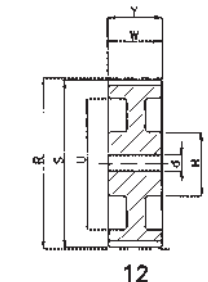

STANDARD «SUPER TORQUE» TIMING PULLEYS FOR ASSEMBLY WITH SER-SIT® CONICAL BUSHES

POULIES DENTEES DE SERIE «SUPER TORQUE» POUR MONTAGE AVEC MOYEU AMOVIBLE SER-SIT®

STANDARD-ZAHNSCHEIBEN «SUPER TORQUE» ZUR MONTAGE MIT SER-SIT® SPANNBUCHSEN

POLEAS DENTADAS DE SERIE «SUPER TORQUE» PARA MONTAJE CON BUJE CONICO SER-SIT®

Pitch - Pas
Teilung - Paso **8 mm**

S 8 M-20

code code Code código	teeth dents Zähne dientes	type type Typ tipo	R mm	S mm	Øe mm	U mm	W mm	H mm	Z mm	Y mm	SER-SIT® code	flange flasque Bord valona	material materiel Werkstoff material
B 22 S 8 M 20	22	4	56,02	54,65	62	38	28	-	6	22	1008	with flanges avec flasques mit Borde con valona	cast iron - fonte - Grauguss - fundición
B 24 S 8 M 20	24	4	61,12	59,74	67	42	28	-	6	22	1108		
B 26 S 8 M 20	26	4	66,21	64,84	73	45	28	-	6	22	1108		
B 28 S 8 M 20	28	4	71,30	69,93	77	52	28	-	6	22	1108		
B 30 S 8 M 20	30	4	76,39	75,02	84	56	28	-	6	22	1108		
B 32 S 8 M 20	32	4	81,49	80,12	88	65	28	-	3	25	1610		
B 34 S 8 M 20	34	4	86,58	85,21	94	66	28	-	3	25	1610		
B 36 S 8 M 20	36	4	91,67	90,30	98	68	28	-	3	25	1610		
B 38 S 8 M 20	38	4	96,77	95,39	104	76	28	-	3	25	1610		
B 40 S 8 M 20	40	4	101,86	100,49	108	80	28	-	3	25	1610		
B 44 S 8 M 20	44	1	112,05	110,67	121	-	28	99	4	32	2012		
B 48 S 8 M 20	48	1	122,23	120,86	129	-	28	105	4	32	2012		
B 56 S 8 M 20	56	1	142,60	141,23	149	-	28	105	4	32	2012		
B 64 S 8 M 20	64	6	162,97	161,60	168	140	28	110	4	32	2012		
B 72 S 8 M 20	72	6	183,35	181,97	191	158	28	110	4	32	2012		
B 80 S 8 M 20	80	9	203,72	202,35	-	178	28	110	4	32	2012		
B 90 S 8 M 20	90	12	229,18	227,81	-	204	28	110	4	32	2012		

★ without flanges - sous flasques - ohne Borde - sin valona

S 8 M-30

code code Code código	teeth dents Zähne dientes	type type Typ tipo	R mm	S mm	Øe mm	U mm	W mm	H mm	Z mm	Y mm	SER-SIT® code	flange flasque Bord valona	material materiel Werkstoff material
B 22 S 8 M 30	22	4	56,02	54,65	62	38	38	-	16	22	1008	with flanges avec flasques mit Borde con valona	cast iron - fonte - Grauguss - fundición
B 24 S 8 M 30	24	4	61,12	59,74	67	42	38	-	16	22	1108		
B 26 S 8 M 30	26	4	66,21	64,84	73	45	38	-	16	22	1108		
B 28 S 8 M 30	28	4	71,30	69,93	77	52	38	-	16	22	1108		
B 30 S 8 M 30	30	8	76,39	75,02	84	-	38	-	-	38	1615		
B 32 S 8 M 30	32	8	81,49	80,12	88	-	38	-	-	38	1615		
B 34 S 8 M 30	34	8	86,58	85,21	94	-	38	-	-	38	1615		
B 36 S 8 M 30	36	8	91,67	90,30	98	-	38	-	-	38	1615		
B 38 S 8 M 30	38	8	96,77	95,39	104	-	38	-	-	38	1615		
B 40 S 8 M 30	40	8	101,86	100,49	108	-	38	-	-	38	1615		
B 44 S 8 M 30	44	2	112,05	110,67	121	90	38	-	-	32	2012		
B 48 S 8 M 30	48	2	122,23	120,86	129	98	38	-	3	32	2012		
B 56 S 8 M 30	56	2	142,60	141,23	149	118	38	-	3	32	2012		
B 64 S 8 M 30	64	6	162,97	161,60	168	140	38	120	3	45	2517		
B 72 S 8 M 30	72	6	183,35	181,97	191	158	38	120	7	45	2517		
B 80 S 8 M 30	80	9	203,72	202,35	-	178	38	120	7	45	2517		
B 90 S 8 M 30	90	12	229,18	227,81	-	204	38	120	7	45	2517		
B 112 S 8 M 30	112	12	285,21	283,83	-	260	38	120	7	45	2517		
B 144 S 8 M 30	144	12	366,69	365,32	-	341	38	120	7	45	2517		

S 8 M-50

code code Code código	teeth dents Zähne dientes	type type Typ tipo	R mm	S mm	Øe mm	U mm	W mm	H mm	Z mm	Y mm	SER-SIT® code	flange flasque Bord valona	material materiel Werkstoff material
B 28 S 8 M 50	28	2	71,30	69,93	77	52	60	-	19	22	1108	with flanges avec flasques mit Borde con valona	cast iron - fonte - Grauguss - fundición
B 30 S 8 M 50	30	4	76,39	75,02	84	58	60	-	22	38	1615		
B 32 S 8 M 50	32	4	81,49	80,12	88	60	60	-	22	38	1615		
B 34 S 8 M 50	34	4	86,58	85,21	94	66	60	-	22	38	1615		
B 36 S 8 M 50	36	4	91,67	90,30	98	68	60	-	22	38	1615		
B 38 S 8 M 50	38	4	96,77	95,39	104	75	60	-	22	38	1615		
B 40 S 8 M 50	40	2	101,86	100,49	108	80	60	-	14	32	2012		
B 44 S 8 M 50	44	2	112,05	110,67	121	90	60	-	14	32	2012		
B 48 S 8 M 50	48	2	122,23	120,86	129	100	60	-	14	32	2012		
B 56 S 8 M 50	56	2	142,60	141,23	149	120	60	-	7,5	45	2517		
B 64 S 8 M 50	64	5	162,97	161,60	168	138	60	120	7,5	45	2517		
B 72 S 8 M 50	72	5	183,35	181,97	191	158	60	120	7,5	45	2517		
B 80 S 8 M 50	80	7	203,72	202,35	-	178	60	140	4,5	51	3020		
B 90 S 8 M 50	90	7	229,18	227,81	-	204	60	146	4,5	51	3020		
B 112 S 8 M 50	112	14	285,21	283,83	-	260	60	146	4,5	51	3020		
B 144 S 8 M 50	144	14	366,69	365,32	-	341	60	146	4,5	51	3020		
B 168 S 8 M 50	168	14	427,80	426,42	-	402	60	146	4,5	51	3020		
B 192 S 8 M 50	192	14	488,92	487,54	-	462	60	146	4,5	51	3020		

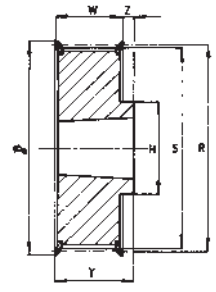

1

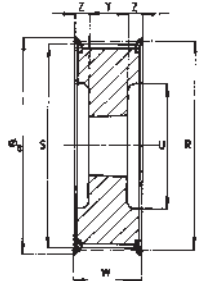

2

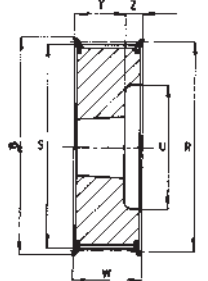

3

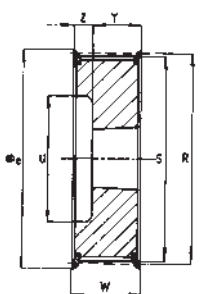

4

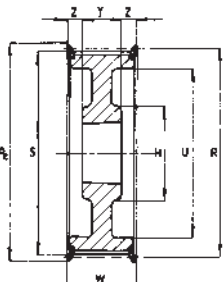

5

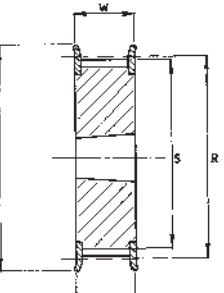

6

S 8 M-85

code code Code código	teeth dents Zähne dientes	type type Typ tipo	R mm	S mm	Øe mm	U mm	W mm	H mm	Z mm	Y mm	SER-SIT® code	flange flasque Bord valona	material materiel Werkstoff material
B 34 S 8 M 85	34	2	86,58	85,21	94	66	95	-	28,5	38	1615	with flanges avec flasques mit Borde con valona	cast iron - fonte - Grauguss - fundición
B 36 S 8 M 85	36	2	91,67	90,30	98	68	95	-	28,5	38	1615		
B 38 S 8 M 85	38	2	96,77	95,39	104	75	95	-	28,5	38	1615		
B 40 S 8 M 85	40	2	101,86	100,49	108	80	95	-	31,5	32	2012		
B 44 S 8 M 85	44	2	112,05	110,67	121	90	95	-	31,5	32	2012		
B 48 S 8 M 85	48	2	122,23	120,86	129	100	95	-	25	45	2517		
B 56 S 8 M 85	56	2	142,60	141,23	149	120	95	-	25	45	2517		
B 64 S 8 M 85	64	2	162,97	161,60	168	138	95	-	25	45	2517		
B 72 S 8 M 85	72	2	183,35	181,97	191	158	95	-	22	51	3020		
B 80 S 8 M 85	80	7	203,72	202,35	-	178	95	140	22	51	3020		
B 90 S 8 M 85	90	7	229,18	227,81	-	204	95	146	22	51	3020		
B 112 S 8 M 85	112	14	285,21	283,83	-	260	95	146	22	51	3020		
B 144 S 8 M 85	144	14	366,69	365,32	-	341	95	140	9,5	76	3030		
B 168 S 8 M 85	168	14	427,80	426,42	-	402	95	140	9,5	76	3030		
B 192 S 8 M 85	192	14	488,92	487,54	-	462	95	140	9,5	76	3030		

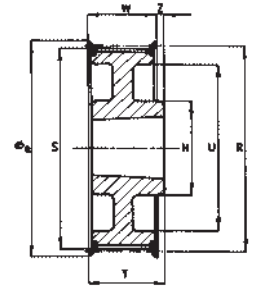

6

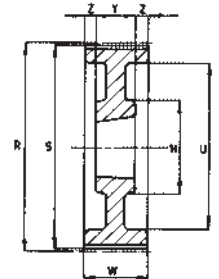

7

Pitch - Pas
Teilung - Paso **14 mm**

S 14 M-40

code code Code código	teeth dents Zähne dientes	type type Typ tipo	R mm	S mm	Øe mm	U mm	W mm	H mm	Z mm	Y mm	SER-SIT® code	flange flasque Bord valona	material materiel Werkstoff material
B 28 S 14 M 40	28	2	124,78	121,98	134	98	54	-	11	32	2012	with flanges avec flasques mit Borde con valona	cast iron - fonte - Grauguss - fundición
B 29 S 14 M 40	29	2	129,23	126,44	134	100	54	-	11	32	2012		
B 30 S 14 M 40	30	2	133,69	130,90	142	100	54	-	11	32	2012		
B 32 S 14 M 40	32	2	142,60	139,81	150	104	54	-	11	32	2012		
B 34 S 14 M 40	34	2	151,51	148,72	158	110	54	-	4,5	45	2517		
B 36 S 14 M 40	36	2	160,43	157,63	166	120	54	-	4,5	45	2517		
B 38 S 14 M 40	38	2	169,34	166,55	177	130	54	-	4,5	45	2517		
B 40 S 14 M 40	40	2	178,25	175,46	186	138	54	-	4,5	45	2517		
B 44 S 14 M 40	44	2	196,08	193,28	209	154	54	-	1,5	51	3020		
B 48 S 14 M 40	48	2	213,90	211,11	216	172	54	-	1,5	51	3020		
B 56 S 14 M 40	56	5	249,56	246,76	261	207	54	146	1,5	51	3020		
B 64 S 14 M 40	64	5	285,21	282,41	288	243	54	146	1,5	51	3020		
B 72 S 14 M 40	72	7	320,86	318,06	-	279	54	146	1,5	51	3020		
B 80 S 14 M 40	80	14	356,51	353,71	-	314	54	146	1,5	51	3020		
B 90 S 14 M 40	90	14	401,07	398,28	-	359	54	146	1,5	51	3020		
B 112 S 14 M 40	112	14	499,11	496,32	-	457	54	146	1,5	51	3020		
B 144 S 14 M 40	144	14	641,71	638,92	-	600	54	146	1,5	51	3020		

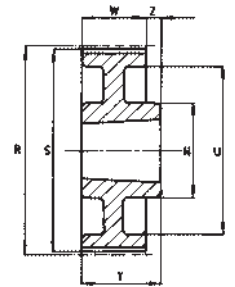

9

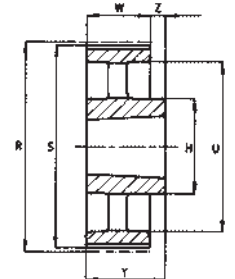

12

S 14 M-55

code code Code código	teeth dents Zähne dientes	type type Typ tipo	R mm	S mm	Øe mm	U mm	W mm	H mm	Z mm	Y mm	SER-SIT® code	flange flasque Bord valona	material materiel Werkstoff material
B 28 S 14 M 55	28	2	124,78	121,98	134	98	70	-	19	32	2012	with flanges avec flasques mit Borde con valona	cast iron - fonte - Grauguss - fundición
B 29 S 14 M 55	29	2	129,23	126,44	134	100	70	-	19	32	2012		
B 30 S 14 M 55	30	2	133,69	130,90	142	100	70	-	12,5	45	2517		
B 32 S 14 M 55	32	2	142,60	139,81	150	104	70	-	12,5	45	2517		
B 34 S 14 M 55	34	2	151,51	148,72	158	110	70	-	12,5	45	2517		
B 36 S 14 M 55	36	2	160,43	157,63	166	120	70	-	12,5	45	2517		
B 38 S 14 M 55	38	2	169,34	166,55	177	130	70	-	12,5	45	2517		
B 40 S 14 M 55	40	2	178,25	175,46	186	138	70	-	12,5	45	2517		
B 44 S 14 M 55	44	2	196,08	193,28	209	154	70	-	9,5	51	3020		
B 48 S 14 M 55	48	2	213,90	211,11	216	172	70	-	9,5	51	3020		
B 56 S 14 M 55	56	5	249,56	246,76	261	207	70	146	9,5	51	3020		
B 64 S 14 M 55	64	5	285,21	282,41	288	243	70	146	9,5	51	3020		
B 72 S 14 M 55	72	7	320,86	318,06	-	279	70	146	9,5	51	3020		
B 80 S 14 M 55	80	14	356,51	353,71	-	314	70	146	9,5	51	3020		
B 90 S 14 M 55	90	14	401,07	398,28	-	359	70	146	9,5	51	3020		
B 112 S 14 M 55	112	14	499,11	496,32	-	457	70	146	9,5	51	3020		
B 144 S 14 M 55	144	14	641,71	638,92	-	600	70	146	9,5	51	3020		

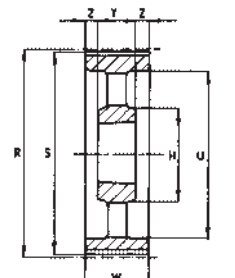

14

S 14 M-85

code code Code código	teeth dents Zähne dientes	type type Typ tipo	R mm	S mm	Øe mm	U mm	W mm	H mm	Z mm	Y mm	SER-SIT code	flange flasque Bord valona	material materiel Werkstoff material
B 28 S 14 M 85	28	2	124,78	121,98	134	98	102	-	28,5	45	2517	with flanges avec flasques mit Borde con valona	cast iron - fonte - Grauguss - fundición
B 29 S 14 M 85	29	2	129,23	126,44	134	100	102	-	28,5	45	2517		
B 30 S 14 M 85	30	2	133,69	130,90	142	100	102	-	28,5	45	2517		
B 32 S 14 M 85	32	2	142,60	139,81	150	104	102	-	28,5	45	2517		
B 34 S 14 M 85	34	2	151,51	148,72	158	110	102	-	28,5	45	2517		
B 36 S 14 M 85	36	2	160,43	157,63	166	120	102	-	25,5	51	3020		
B 38 S 14 M 85	38	2	169,34	166,55	177	130	102	-	25,5	51	3020		
B 40 S 14 M 85	40	2	178,25	175,46	186	138	102	-	25,5	51	3020		
B 44 S 14 M 85	44	2	196,08	193,28	209	154	102	-	13	76	3030		
B 48 S 14 M 85	48	2	213,90	211,11	216	172	102	-	13	76	3030		
B 56 S 14 M 85	56	2	249,56	246,76	261	207	102	-	6,5	89	3535		
B 64 S 14 M 85	64	5	285,21	282,41	288	243	102	178	6,5	89	3535		
B 72 S 14 M 85	72	7	320,86	318,06	-	279	102	178	6,5	89	3535		
B 80 S 14 M 85	80	14	356,51	353,71	-	314	102	178	6,5	89	3535		
B 90 S 14 M 85	90	14	401,07	398,28	-	359	102	178	6,5	89	3535		
B 112 S 14 M 85	112	14	499,11	496,32	-	457	102	178	6,5	89	3535		
B 144 S 14 M 85	144	14	641,71	638,92	-	600	102	178	6,5	89	3535		

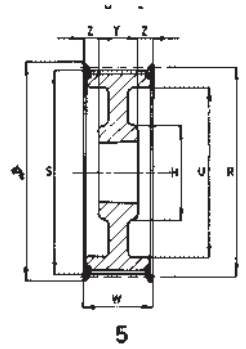
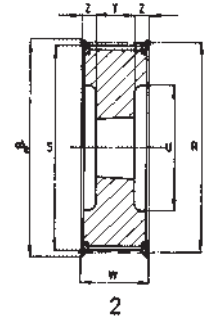

S 14 M-115

code code Code código	teeth dents Zähne dientes	type type Typ tipo	R mm	S mm	Øe mm	U mm	W mm	H mm	Z mm	Y mm	SER-SIT code	flange flasque Bord valona	material materiel Werkstoff material
B 28 S 14 M 115	28	2	124,78	121,98	134	98	133	-	44	45	2517	with flanges avec flasques mit Borde con valona	cast iron - fonte - Grauguss - fundición
B 29 S 14 M 115	29	2	129,23	126,44	134	100	133	-	44	45	2517		
B 30 S 14 M 115	30	2	133,69	130,90	142	100	133	-	44	45	2517		
B 32 S 14 M 115	32	2	142,60	139,81	150	104	133	-	44	45	2517		
B 34 S 14 M 115	34	2	151,51	148,72	158	110	133	-	44	45	2517		
B 36 S 14 M 115	36	2	160,43	157,63	166	120	133	-	41	51	3020		
B 38 S 14 M 115	38	2	169,34	166,55	177	130	133	-	41	51	3020		
B 40 S 14 M 115	40	2	178,25	175,46	186	138	133	-	41	51	3020		
B 44 S 14 M 115	44	2	196,08	193,28	209	154	133	-	28,5	76	3030		
B 48 S 14 M 115	48	2	213,90	211,11	216	172	133	-	28,5	76	3030		
B 56 S 14 M 115	56	2	249,56	246,76	261	207	133	-	22	89	3535		
B 64 S 14 M 115	64	5	285,21	282,41	288	243	133	178	22	89	3535		
B 72 S 14 M 115	72	7	320,86	318,06	-	279	133	178	22	89	3535		
B 80 S 14 M 115	80	14	356,51	353,71	-	314	133	178	22	89	3535		
B 90 S 14 M 115	90	14	401,07	398,28	-	359	133	178	22	89	3535		
B 112 S 14 M 115	112	14	499,11	496,32	-	457	133	178	22	89	3535		
B 144 S 14 M 115	144	14	641,71	638,92	-	600	133	215	15,5	102	4040		

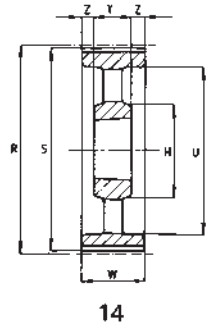
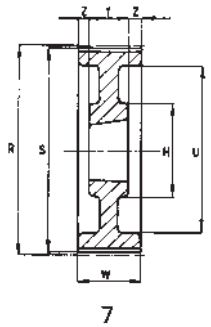

S 14 M-170

code code Code código	teeth dents Zähne dientes	type type Typ tipo	R mm	S mm	Øe mm	U mm	W mm	H mm	Z mm	Y mm	SER-SIT code	flange flasque Bord valona	material materiel Werkstoff material
B 38 S 14 M 170	38	2	169,34	166,55	177	130	187	-	55,5	76	3030	with flanges avec flasques mit Borde con valona	cast iron - fonte - Grauguss - fundición
B 40 S 14 M 170	40	2	178,25	175,46	186	138	187	-	55,5	76	3030		
B 44 S 14 M 170	44	2	196,08	193,28	209	154	187	-	49	89	3535		
B 48 S 14 M 170	48	2	213,90	211,11	216	172	187	-	49	89	3535		
B 56 S 14 M 170	56	2	249,56	246,76	261	207	187	-	49	89	3535		
B 64 S 14 M 170	64	2	285,21	282,41	288	243	187	-	42,5	102	4040		
B 72 S 14 M 170	72	2	320,86	318,06	-	279	187	215	42,5	102	4040		
B 80 S 14 M 170	80	7	356,51	353,71	-	314	187	215	42,5	102	4040		
B 90 S 14 M 170	90	14	401,07	398,28	-	359	187	215	42,5	102	4040		
B 112 S 14 M 170	112	14	499,11	496,32	-	457	187	267	30	127	5050		
B 144 S 14 M 170	144	14	641,71	638,92	-	600	187	267	30	127	5050		

STANDARD «TOP DRIVE® HTD» TIMING PULLEYS
POULIES DENTEES «TOP DRIVE® HTD» DE SERIE
STANDARD-ZAHNSCHEIBEN «TOP DRIVE® HTD»
POLEAS DENTADAS «TOP DRIVE® HTD» DE SERIE

Pitch - Pas
 Teilung - Paso **3 mm**

3 M 09

code code Code código	teeth dents Zähne dientes	type type Typ tipo	R mm	S mm	Øe mm	H mm	W mm	Y mm	Z mm	flange flasque Bord valona	material materiel Werkstoff material
10 - 3 M 09	10	3	9,55	8,79	12,0	12,0	10,2	17,5	7,3	with flanges avec flasques mit Borde con valona	Aluminium Aluminium Aluminium Aluminio
12 - 3 M 09	12	3	11,46	10,70	16,0	15,0	10,2	17,5	7,3		
14 - 3 M 09	14	3	13,37	12,61	18,0	18,0	10,2	17,5	7,3		
15 - 3 M 09	15	3	14,32	13,56	16,0	18,0	10,2	17,5	7,3		
16 - 3 M 09	16	1	15,28	14,52	20,0	10,0	12,8	20,6	7,8		
18 - 3 M 09	18	1	17,19	16,43	20,0	11,0	12,8	20,6	7,8		
20 - 3 M 09	20	1	19,10	18,34	23,0	13,0	12,8	20,6	7,8		
21 - 3 M 09	21	1	20,05	19,29	24,0	14,0	12,8	20,6	7,8		
22 - 3 M 09	22	1	21,01	20,05	25,0	14,0	12,8	20,6	7,8		
24 - 3 M 09	24	1	22,92	22,16	27,0	14,0	12,8	20,6	7,8		
26 - 3 M 09	26	1	24,83	24,07	27,0	16,0	12,8	20,6	7,8		
28 - 3 M 09	28	1	26,74	25,98	30,0	18,0	12,8	20,6	7,8		
30 - 3 M 09	30	1	28,65	27,89	33,0	20,0	12,8	20,6	7,8		
32 - 3 M 09	32	1	30,56	29,80	33,0	22,0	12,8	20,6	7,8		
36 - 3 M 09	36	1	34,38	33,62	40,0	26,0	13,4	22,2	8,8		
40 - 3 M 09	40	1	38,20	37,44	46,0	28,0	13,4	22,2	8,8		
44 - 3 M 09	44	1	42,02	41,26	46,0	33,0	13,4	22,2	8,8		
48 - 3 M 09	48	7	45,84	45,08	-	33,0	13,4	22,2	8,8		
60 - 3 M 09	60	7	57,30	56,54	-	33,0	13,4	22,2	8,8		
72 - 3 M 09	72	7	68,75	67,99	-	33,0	13,4	22,2	8,8		

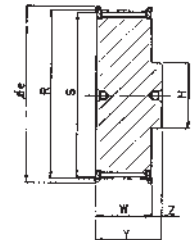

1

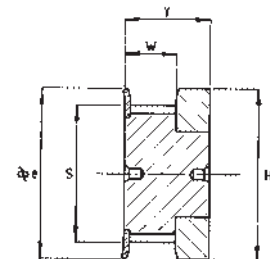

3

3 M 15

code code Code código	teeth dents Zähne dientes	type type Typ tipo	R mm	S mm	Øe mm	H mm	W mm	Y mm	Z mm	flange flasque Bord valona	material materiel Werkstoff material
10 - 3 M 15	10	3	9,55	8,79	12,0	12,0	17,0	26,0	9	with flanges avec flasques mit Borde con valona	Aluminium Aluminium Aluminium Aluminio
12 - 3 M 15	12	3	11,46	10,70	16,0	15,0	17,0	26,0	9		
14 - 3 M 15	14	3	13,37	12,61	18,0	18,0	17,0	26,0	9		
15 - 3 M 15	15	3	14,32	13,56	16,0	18,0	17,0	26,0	9		
16 - 3 M 15	16	1	15,28	14,52	20,0	10,0	19,5	26,0	6,5		
18 - 3 M 15	18	1	17,19	16,43	20,0	11,0	19,5	26,0	6,5		
20 - 3 M 15	20	1	19,10	18,34	23,0	13,0	19,5	26,0	6,5		
21 - 3 M 15	21	1	20,05	19,29	24,0	14,0	19,5	26,0	6,5		
22 - 3 M 15	22	1	21,01	20,05	25,0	14,0	19,5	26,0	6,5		
24 - 3 M 15	24	1	22,92	22,16	27,0	14,0	19,5	26,0	6,5		
26 - 3 M 15	26	1	24,83	24,07	27,0	16,0	19,5	26,0	6,5		
28 - 3 M 15	28	1	26,74	25,98	30,0	18,0	19,5	26,0	6,5		
30 - 3 M 15	30	1	28,65	27,89	33,0	20,0	19,5	26,0	6,5		
32 - 3 M 15	32	1	30,56	29,80	33,0	22,0	19,5	26,0	6,5		
36 - 3 M 15	36	1	34,38	33,62	40,0	26,0	20,0	30,0	10		
40 - 3 M 15	40	1	38,20	37,44	46,0	28,0	20,0	30,0	10		
44 - 3 M 15	44	1	42,02	41,26	46,0	33,0	20,0	30,0	10		
48 - 3 M 15	48	7	45,84	45,08	-	33,0	20,0	30,0	10		
60 - 3 M 15	60	7	57,30	56,54	-	33,0	20,0	30,0	10		
72 - 3 M 15	72	7	68,75	67,99	-	33,0	20,0	30,0	10		

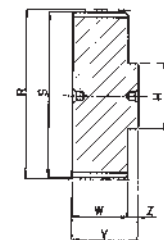

7

Pitch - Pas
Teilung - Paso **5 mm**

5 M 09

code code Code Código	teeth dents Zähne dientes	type type Typ tipo	R mm	S mm	Øe mm	U mm	W mm	H mm	Y mm	Z mm	flange flasque Bord valona	material materiel Werkstoff material
12 - 5 M 09	12	1	19,10	17,96	23	-	14,5	13,0	20,0	5,5	with flanges avec flasques mit Borde con valona	steel acier Stahl acero
14 - 5 M 09	14	1	22,28	21,14	24	-	14,5	14,0	20,0	5,5		
15 - 5 M 09	15	1	23,87	22,73	27	-	14,5	16,0	20,0	5,5		
16 - 5 M 09	16	1	25,47	24,32	27	-	14,5	16,5	20,0	5,5		
18 - 5 M 09	18	1	28,65	27,51	30	-	14,5	20,0	20,0	5,5		
20 - 5 M 09	20	1	31,83	30,69	33	-	14,5	23,0	22,5	8,0		
21 - 5 M 09	21	1	33,42	32,28	36	-	14,5	24,0	22,5	8,0		
22 - 5 M 09	22	1	35,01	33,87	36	-	14,5	25,0	22,5	8,0		
24 - 5 M 09	24	1	38,19	37,06	40	-	14,5	27,0	22,5	8,0		
26 - 5 M 09	26	1	41,38	40,24	46	-	14,5	30,0	22,5	8,0		
28 - 5 M 09	28	1	44,56	43,42	50	-	14,5	30,5	22,5	8,0		
30 - 5 M 09	30	1	47,75	46,61	50	-	14,5	35,0	22,5	8,0		
32 - 5 M 09	32	1	50,93	49,79	55	-	14,5	38,0	22,5	8,0		
36 - 5 M 09	36	1	57,30	56,16	62	-	14,5	38,0	22,5	8,0		
40 - 5 M 09	40	1	63,66	62,52	67	-	14,5	38,0	22,5	8,0		
44 - 5 M 09	44	7	70,03	68,89	-	-	14,5	38,0	25,5	11,0		
48 - 5 M 09	48	7	76,39	75,25	-	-	14,5	45,0	25,5	11,0		
60 - 5 M 09	60	7	95,49	94,35	-	-	14,5	45,0	25,5	11,0		
72 - 5 M 09	72	3	114,59	113,45	-	90	14,5	45,0	25,5	11,0		

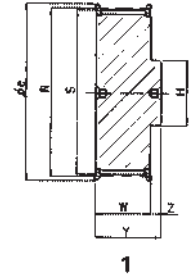

1

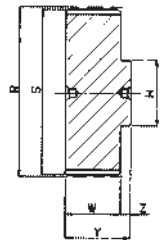

7

5 M 15

code code Code Código	teeth dents Zähne dientes	type type Typ tipo	R mm	S mm	Øe mm	U mm	W mm	H mm	Y mm	Z mm	flange flasque Bord valona	material materiel Werkstoff material
12 - 5 M 15	12	1	19,10	17,96	23	-	20,5	13,0	26,0	5,5	with flanges avec flasques mit Borde con valona	steel acier Stahl acero
14 - 5 M 15	14	1	22,28	21,14	24	-	20,5	14,0	26,0	5,5		
15 - 5 M 15	15	1	23,87	22,73	27	-	20,5	16,0	26,0	5,5		
16 - 5 M 15	16	1	25,47	24,32	27	-	20,5	16,5	26,0	5,5		
18 - 5 M 15	18	1	28,65	27,51	30	-	20,5	20,0	26,0	5,5		
20 - 5 M 15	20	1	31,83	30,69	33	-	20,5	23,0	26,0	5,5		
21 - 5 M 15	21	1	33,42	32,28	36	-	20,5	24,0	26,0	5,5		
22 - 5 M 15	22	1	35,01	33,87	36	-	20,5	25,5	26,0	5,5		
24 - 5 M 15	24	1	38,19	37,06	40	-	20,5	27,0	28,0	7,5		
26 - 5 M 15	26	1	41,38	40,24	46	-	20,5	30,0	28,0	7,5		
28 - 5 M 15	28	1	44,56	43,42	50	-	20,5	30,5	28,0	7,5		
30 - 5 M 15	30	1	47,75	46,61	50	-	20,5	35,0	28,0	7,5		
32 - 5 M 15	32	1	50,93	49,79	55	-	20,5	38,0	28,0	7,5		
36 - 5 M 15	36	1	57,30	56,16	62	-	20,5	38,0	28,0	7,5		
40 - 5 M 15	40	1	63,66	62,52	67	-	20,5	38,0	28,0	7,5		
44 - 5 M 15	44	7	70,03	68,89	-	-	20,5	38,0	30,0	9,5		
48 - 5 M 15	48	7	76,39	75,25	-	-	20,5	38,0	30,0	9,5		
60 - 5 M 15	60	7	95,49	94,35	-	-	20,5	50,0	30,0	9,5		
72 - 5 M 15	72	3	114,59	113,45	-	90	20,5	50,0	30,0	9,5		

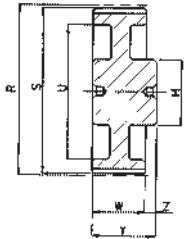

3

5 M 25

code code Code Código	teeth dents Zähne dientes	type type Typ tipo	R mm	S mm	Øe mm	U mm	W mm	H mm	Y mm	Z mm	flange flasque Bord valona	material materiel Werkstoff material
12 - 5 M 25	12	1	19,10	17,96	23	-	30,0	13,0	36,0	6	with flanges avec flasques mit Borde con valona	steel acier Stahl acero
14 - 5 M 25	14	1	22,28	21,14	24	-	30,0	14,0	36,0	6		
15 - 5 M 25	15	1	23,87	22,73	27	-	30,0	16,0	36,0	6		
16 - 5 M 25	16	1	25,47	24,32	27	-	30,0	16,5	36,0	6		
18 - 5 M 25	18	1	28,65	27,51	30	-	30,0	20,0	36,0	6		
20 - 5 M 25	20	1	31,83	30,69	33	-	30,0	23,0	36,0	6		
21 - 5 M 25	21	1	33,42	32,28	36	-	30,0	24,0	38,0	8		
22 - 5 M 25	22	1	35,01	33,87	36	-	30,0	25,5	38,0	8		
24 - 5 M 25	24	1	38,19	37,06	40	-	30,0	27,0	38,0	8		
26 - 5 M 25	26	1	41,38	40,24	46	-	30,0	30,0	38,0	8		
28 - 5 M 25	28	1	44,56	43,42	50	-	30,0	30,5	38,0	8		
30 - 5 M 25	30	1	47,75	46,61	50	-	30,0	35,0	38,0	8		
32 - 5 M 25	32	1	50,93	49,79	55	-	30,0	38,0	38,0	8		
36 - 5 M 25	36	1	57,30	56,16	62	-	30,0	38,0	38,0	8		
40 - 5 M 25	40	1	63,66	62,52	67	-	30,0	38,0	38,0	8		
44 - 5 M 25	44	7	70,03	68,89	-	-	30,0	38,0	40,0	10		
48 - 5 M 25	48	7	76,39	75,25	-	-	30,0	38,0	40,0	10		
60 - 5 M 25	60	7	95,49	94,35	-	-	30,0	50,0	40,0	10		
72 - 5 M 25	72	3	114,59	113,45	-	90	30,0	50,0	40,0	10		

Pitch - Pas
Teilung - Paso

8 mm

8 M 20

code code Code código	teeth dents Zähne dientes	type type Typ tipo	R mm	S mm	Øe mm	U mm	W mm	H mm	Y mm	Z mm	Ød mm	flange flasque Bord valona	material materiel Werkstoff material
18 - 8 M 20	18	1	45,84	44,46	50	-	28	32	38	10	-	with flanges avec flasques mit Borde con valona	steel acier Stahl acero
20 - 8 M 20	20	1	50,93	49,56	55	-	28	36	38	10	-		
22 - 8 M 20	22	1	56,02	54,65	62	-	28	43	38	10	-		
24 - 8 M 20	24	1	61,12	59,74	67	-	28	49	38	10	-		
26 - 8 M 20	26	1	66,21	64,84	73	-	28	50	38	10	-		
28 - 8 M 20	28	1	71,30	69,93	77	-	28	55	38	10	-		
30 - 8 M 20	30	1	76,39	75,02	84	-	28	60	38	10	-		
32 - 8 M 20	32	1	81,49	80,12	88	-	28	64	38	10	-		
34 - 8 M 20	34	1	86,58	85,21	94	-	28	70	38	10	-		
36 - 8 M 20	36	1	91,67	90,30	98	-	28	75	38	10	-		
38 - 8 M 20	38	1	96,77	95,39	104	-	28	80	38	10	-		
40 - 8 M 20	40	1	101,86	100,49	108	-	28	85	38	10	-		
44 - 8 M 20	44	1	112,05	110,67	121	-	28	96	38	10	-		
48 - 8 M 20	48	1	122,23	120,86	129	-	28	104	38	10	-		
56 - 8 M 20	56	2	142,60	141,23	149	117	28	80	38	10	-		
60 - 8 M 20	60	2	152,79	151,42	158	127	28	80	38	10	-		
64 - 8 M 20	64	2	162,97	161,60	168	137	28	80	38	10	-		
72 - 8 M 20	72	2	183,35	181,97	191	158	28	80	38	10	-		
80 - 8 M 20	80	6	203,72	202,35	-	179	28	90	38	10	-		
84 - 8 M 20	84	6	213,90	212,53	-	190	28	90	38	10	-		
90 - 8 M 20	90	6	229,18	227,81	-	204	28	90	38	10	-		
112 - 8 M 20	112	5	285,21	283,83	-	260	28	90	38	10	19		
144 - 8 M 20	144	5	366,69	365,32	-	342	28	90	38	10	19		
168 - 8 M 20	168	5	427,80	426,42	-	403	28	100	38	10	19		
192 - 8 M 20	192	5	488,92	487,54	-	465	28	100	38	10	19		

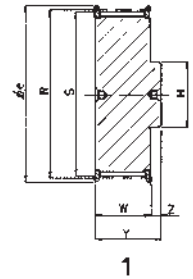

1

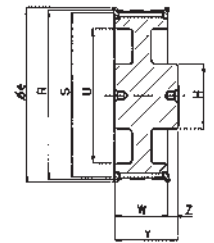

2

8 M-30

code code Code código	teeth dents Zähne dientes	type type Typ tipo	R mm	S mm	Øe mm	U mm	W mm	H mm	Y mm	Z mm	Ød mm	flange flasque Bord valona	material materiel Werkstoff material
18 - 8 M 30	18	1	45,84	44,46	50	-	38	32	48	10	-	with flanges avec flasques mit Borde con valona	steel acier Stahl acero
20 - 8 M 30	20	1	50,93	49,56	55	-	38	36	48	10	-		
22 - 8 M 30	22	1	56,02	54,65	62	-	38	43	48	10	-		
24 - 8 M 30	24	1	61,12	59,74	67	-	38	49	48	10	-		
26 - 8 M 30	26	1	66,21	64,84	73	-	38	50	48	10	-		
28 - 8 M 30	28	1	71,30	69,93	77	-	38	55	48	10	-		
30 - 8 M 30	30	1	76,39	75,02	84	-	38	60	48	10	-		
32 - 8 M 30	32	1	81,49	80,12	88	-	38	64	48	10	-		
34 - 8 M 30	34	1	86,58	85,21	94	-	38	70	48	10	-		
36 - 8 M 30	36	1	91,67	90,30	98	-	38	75	48	10	-		
38 - 8 M 30	38	1	96,77	95,39	104	-	38	80	48	10	-		
40 - 8 M 30	40	1	101,86	100,49	108	-	38	85	48	10	-		
44 - 8 M 30	44	1	112,05	110,67	121	-	38	96	48	10	-		
48 - 8 M 30	48	1	122,23	120,86	129	-	38	104	48	10	-		
56 - 8 M 30	56	2	142,60	141,23	149	117	38	90	48	10	-		
60 - 8 M 30	60	2	152,79	151,42	158	127	38	90	48	10	-		
64 - 8 M 30	64	2	162,97	161,60	168	137	38	90	48	10	-		
72 - 8 M 30	72	2	183,35	181,97	191	158	38	95	48	10	-		
80 - 8 M 30	80	6	203,72	202,35	-	179	38	100	48	10	-		
84 - 8 M 30	84	6	213,90	212,53	-	190	38	100	48	10	-		
90 - 8 M 30	90	6	229,18	227,81	-	204	38	100	48	10	-		
112 - 8 M 30	112	5	285,21	283,83	-	260	38	100	48	10	19		
144 - 8 M 30	144	5	366,69	365,32	-	342	38	100	48	10	19		
168 - 8 M 30	168	5	427,80	426,42	-	403	38	100	48	10	19		
192 - 8 M 30	192	5	488,92	487,54	-	465	38	100	48	10	19		

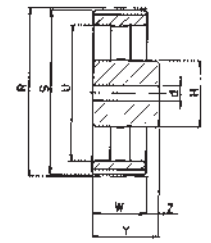

5

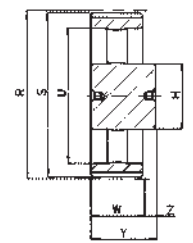

6

8 M 50

code code Code código	teeth dents Zähne dientes	type type Typ tipo	R mm	S mm	Øe mm	U mm	W mm	H mm	Y mm	Z mm	Ød mm	flange flasque Bord valona	material materiel Werkstoff material
18 - 8 M 50	18	1	45,84	44,46	50	-	60	32	70	10	-	with flanges avec flasques mit Borde con valona	steel acier Stahl acero
20 - 8 M 50	20	1	50,93	49,56	55	-	60	36	70	10	-		
22 - 8 M 50	22	1	56,02	54,65	62	-	60	43	70	10	-		
24 - 8 M 50	24	1	61,12	59,74	67	-	60	49	70	10	-		
26 - 8 M 50	26	1	66,21	64,84	73	-	60	50	70	10	-		
28 - 8 M 50	28	1	71,30	69,93	77	-	60	55	70	10	-		
30 - 8 M 50	30	1	76,39	75,02	84	-	60	60	70	10	-		
32 - 8 M 50	32	1	81,49	80,12	88	-	60	64	70	10	-		
34 - 8 M 50	34	1	86,58	85,21	94	-	60	70	70	10	-		
36 - 8 M 50	36	1	91,67	90,30	98	-	60	75	70	10	-		
38 - 8 M 50	38	1	96,77	95,39	104	-	60	80	70	10	-		
40 - 8 M 50	40	1	101,86	100,49	108	-	60	85	70	10	-		
44 - 8 M 50	44	1	112,05	110,67	121	-	60	96	70	10	-		
48 - 8 M 50	48	1	122,23	120,86	129	-	60	104	70	10	-		
56 - 8 M 50	56	8	142,60	141,23	149	117	60	90	60	-	-	without flanges sous flasques ohne Borde sin valona	cast iron fonte Grauguss fundición
60 - 8 M 50	60	8	152,79	151,42	158	127	60	100	60	-	-		
64 - 8 M 50	64	8	162,97	161,60	168	137	60	100	60	-	-		
72 - 8 M 50	72	8	183,35	181,97	191	158	60	100	60	-	-		
80 - 8 M 50	80	9	203,72	202,35	-	179	60	110	60	-	-		
84 - 8 M 50	84	10	213,90	212,53	-	190	60	110	60	-	-		
90 - 8 M 50	90	10	229,18	227,81	-	204	60	110	60	-	-		
112 - 8 M 50	112	11	285,21	283,83	-	260	60	110	60	-	19		
144 - 8 M 50	144	11	366,69	365,32	-	342	60	110	60	-	19		
168 - 8 M 50	168	11	427,80	426,42	-	403	60	120	60	-	19		
192 - 8 M 50	192	11	488,92	487,54	-	465	60	130	60	-	19		

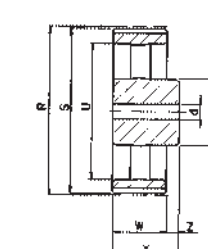
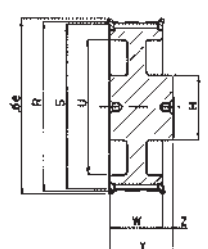
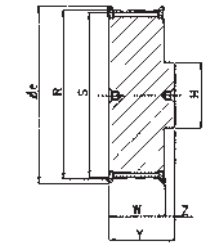

8 M 85

code code Code código	teeth dents Zähne dientes	type type Typ tipo	R mm	S mm	Øe mm	U mm	W mm	H mm	Y mm	Z mm	Ød mm	flange flasque Bord valona	material materiel Werkstoff material
22 - 8 M 85	22	1	56,02	54,65	62	-	95	43	105	10	-	with flanges avec flasques mit Borde con valona	steel acier Stahl acero
24 - 8 M 85	24	1	61,12	59,74	67	-	95	49	105	10	-		
26 - 8 M 85	26	1	66,21	64,84	73	-	95	50	105	10	-		
28 - 8 M 85	28	1	71,30	69,93	77	-	95	55	105	10	-		
30 - 8 M 85	30	1	76,39	75,02	84	-	95	60	105	10	-		
32 - 8 M 85	32	1	81,49	80,12	88	-	95	64	105	10	-		
34 - 8 M 85	34	1	86,58	85,21	94	-	95	70	105	10	-		
36 - 8 M 85	36	1	91,67	90,30	98	-	95	75	105	10	-		
38 - 8 M 85	38	1	96,77	95,39	104	-	95	80	105	10	-		
40 - 8 M 85	40	1	101,86	100,49	108	-	95	85	105	10	-		
44 - 8 M 85	44	1	112,05	110,67	121	-	95	96	105	10	-		
48 - 8 M 85	48	1	122,23	120,86	129	-	95	104	105	10	-		
56 - 8 M 85	56	1	142,60	141,23	149	-	95	107	105	10	-		
60 - 8 M 85	60	1	152,79	151,42	158	-	95	132	105	10	-		
64 - 8 M 85	64	8	162,97	161,60	168	137	95	100	95	-	-	without flanges sous flasques ohne Borde sin valona	cast iron fonte Grauguss fundición
72 - 8 M 85	72	8	183,35	181,97	191	158	95	110	95	-	-		
80 - 8 M 85	80	9	203,72	202,35	-	179	95	110	95	-	-		
84 - 8 M 85	84	9	213,90	212,53	-	190	95	110	95	-	-		
90 - 8 M 85	90	10	229,18	227,81	-	204	95	110	95	-	-		
112 - 8 M 85	112	11	285,21	283,83	-	260	95	110	95	-	19		
144 - 8 M 85	144	11	366,69	365,32	-	342	95	120	95	-	19		
168 - 8 M 85	168	11	427,80	426,42	-	403	95	120	95	-	19		
192 - 8 M 85	192	11	488,92	487,54	-	465	95	130	95	-	19		

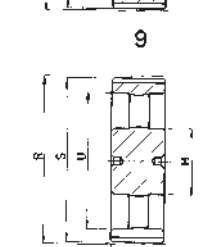
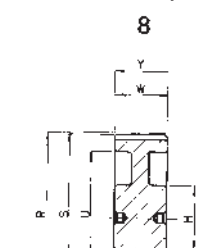
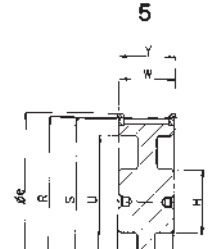

Pitch - Pas
Teilung - Paso **14 mm**

14 M 40

code code Code código	teeth dents Zähne dientes	type type Typ tipo	R mm	S mm	Øe mm	U mm	W mm	H mm	Y mm	Z mm	Ød mm	flange flasque Bord valona	material materiel Werkstoff material
28 - 14 M 40	28	1	124,78	122,12	134	-	54	100	69	15	-	with flanges avec flasques mit Borde con valona	cast iron - fonte - Grauguss - fundición
29 - 14 M 40	29	1	129,23	126,57	134	-	54	107	69	15	-		
30 - 14 M 40	30	1	133,69	130,99	142	-	54	107	69	15	-		
32 - 14 M 40	32	1	142,60	139,88	150	-	54	114	69	15	-		
34 - 14 M 40	34	1	151,51	148,79	158	-	54	122	69	15	-		
36 - 14 M 40	36	1	160,43	157,68	166	-	54	128	69	15	-		
38 - 14 M 40	38	1	169,34	166,60	177	-	54	141	69	15	-		
40 - 14 M 40	40	1	178,25	175,49	186	-	54	148	69	15	-		
44 - 14 M 40	44	2	196,08	193,28	209	154	54	120	69	15	-		
48 - 14 M 40	48	2	213,90	211,11	216	172	54	135	69	15	-		
56 - 14 M 40	56	2	249,56	246,76	261	207	54	135	69	15	-		
60 - 14 M 40	60	2	267,38	264,59	274	225	54	135	69	15	-		
64 - 14 M 40	64	2	285,21	282,41	288	243	54	135	69	15	19		
72 - 14 M 40	72	5	320,86	318,06	-	279	54	135	69	15	19		
80 - 14 M 40	80	5	356,51	353,71	-	314	54	135	69	15	19		
84 - 14 M 40	84	5	374,33	371,54	-	332	54	135	69	15	19		
90 - 14 M 40	90	5	401,07	398,28	-	359	54	135	69	15	19		
112 - 14 M 40	112	5	499,11	496,32	-	457	54	135	69	15	19		
144 - 14 M 40	144	5	641,71	638,92	-	600	54	135	69	15	19		

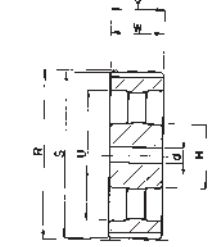
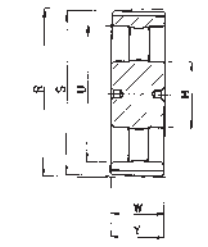

14 M 55

code code Code código	teeth dents Zähne dientes	type type Typ tipo	R mm	S mm	Øe mm	U mm	W mm	H mm	Y mm	Z mm	Ød mm	flange flasque Bord valona	material materiel Werkstoff material
28 - 14 M 55	28	1	124,78	122,12	134	-	70	100	85	15	-	with flanges avec flasques mit Borde con valona	cast iron - fonte - Grauguss - fundición
29 - 14 M 55	29	1	129,23	126,57	134	-	70	107	85	15	-		
30 - 14 M 55	30	1	133,69	130,99	142	-	70	107	85	15	-		
32 - 14 M 55	32	1	142,60	139,88	150	-	70	114	85	15	-		
34 - 14 M 55	34	1	151,51	148,79	158	-	70	122	85	15	-		
36 - 14 M 55	36	1	160,43	157,68	166	-	70	128	85	15	-		
38 - 14 M 55	38	1	169,34	166,60	177	-	70	141	85	15	-		
40 - 14 M 55	40	1	178,25	175,49	186	-	70	148	85	15	-		
44 - 14 M 55	44	2	196,08	193,28	209	154	70	120	85	15	-		
48 - 14 M 55	48	8	213,90	211,11	216	172	70	135	70	-	-		
56 - 14 M 55	56	8	249,56	246,76	261	207	70	135	70	-	-		
60 - 14 M 55	60	8	267,38	264,59	274	225	70	135	70	-	-		
64 - 14 M 55	64	8	285,21	282,41	288	243	70	135	70	-	-		
72 - 14 M 55	72	11	320,86	318,06	-	279	70	135	70	-	19		
80 - 14 M 55	80	11	356,51	353,71	-	314	70	135	70	-	19		
84 - 14 M 55	84	11	374,33	371,54	-	332	70	135	70	-	19		
90 - 14 M 55	90	11	401,07	398,28	-	359	70	135	70	-	19		
112 - 14 M 55	112	11	499,11	496,32	-	457	70	135	70	-	19		
144 - 14 M 55	144	11	641,71	638,92	-	600	70	135	70	-	19		
												without flanges sous flasques ohne Borde sin valona	

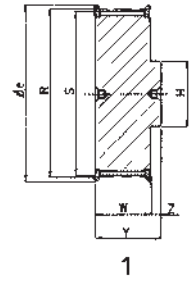

1

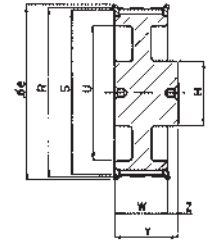

2

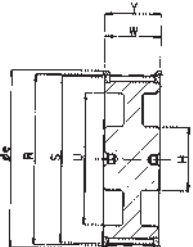

8

14 M 85

code code Code código	teeth dents Zähne dientes	type type Typ tipo	R mm	S mm	Øe mm	U mm	W mm	H mm	Y mm	Z mm	Ød mm	flange flasque Bord valona	material materiel Werkstoff material
28 - 14 M 85	28	1	124,78	122,12	134	-	102	100	117	15	-	with flanges avec flasques mit Borde con valona	cast iron - fonte - Grauguss - fundición
29 - 14 M 85	29	1	129,23	126,57	134	-	102	107	117	15	-		
30 - 14 M 85	30	1	133,69	130,99	142	-	102	107	117	15	-		
32 - 14 M 85	32	1	142,60	139,88	150	-	102	114	117	15	-		
34 - 14 M 85	34	1	151,51	148,79	158	-	102	122	117	15	-		
36 - 14 M 85	36	1	160,43	157,68	166	-	102	128	117	15	-		
38 - 14 M 85	38	1	169,34	166,60	177	-	102	141	117	15	-		
40 - 14 M 85	40	1	178,25	175,49	186	-	102	148	117	15	-		
44 - 14 M 85	44	1	196,08	193,28	209	-	102	169	117	15	-		
48 - 14 M 85	48	1	213,90	211,11	216	-	102	186	117	15	-		
56 - 14 M 85	56	8	249,56	246,76	261	207	102	150	102	-	-		
60 - 14 M 85	60	8	267,38	264,59	274	225	102	150	102	-	-		
64 - 14 M 85	64	8	285,21	282,41	288	243	102	150	102	-	-		
72 - 14 M 85	72	11	320,86	318,06	-	279	102	150	102	-	19		
80 - 14 M 85	80	11	356,51	353,71	-	314	102	150	102	-	19		
84 - 14 M 85	84	11	374,33	371,54	-	332	102	150	102	-	19		
90 - 14 M 85	90	11	401,07	398,28	-	359	102	150	102	-	19		
112 - 14 M 85	112	11	499,11	496,32	-	457	102	150	102	-	19		
144 - 14 M 85	144	11	641,71	638,92	-	600	102	150	102	-	19		
												without flanges sous flasques ohne Borde sin valona	

14 M 115

code code Code código	teeth dents Zähne dientes	type type Typ tipo	R mm	S mm	Øe mm	U mm	W mm	H mm	Y mm	Z mm	Ød mm	flange flasque Bord valona	material materiel Werkstoff material
28 - 14 M 115	28	1	124,78	122,12	134	-	133	100	148	15	-	with flanges avec flasques mit Borde con valona	cast iron - fonte - Grauguss - fundición
29 - 14 M 115	29	1	129,23	126,57	134	-	133	107	148	15	-		
30 - 14 M 115	30	1	133,69	130,99	142	-	133	107	148	15	-		
32 - 14 M 115	32	1	142,60	139,88	150	-	133	114	148	15	-		
34 - 14 M 115	34	1	151,51	148,79	158	-	133	122	148	15	-		
36 - 14 M 115	36	1	160,43	157,68	166	-	133	128	148	15	-		
38 - 14 M 115	38	1	169,34	166,60	177	-	133	141	148	15	-		
40 - 14 M 115	40	1	178,25	175,49	186	-	133	148	148	15	-		
44 - 14 M 115	44	1	196,08	193,28	209	-	133	169	148	15	-		
48 - 14 M 115	48	1	213,90	211,11	216	-	133	186	148	15	-		
56 - 14 M 115	56	2	249,56	246,76	261	207	133	150	148	-	-		
60 - 14 M 115	60	8	267,38	264,59	274	225	133	150	133	-	-		
64 - 14 M 115	64	8	285,21	282,41	288	243	133	150	133	-	-		
72 - 14 M 115	72	11	320,86	318,06	-	279	133	150	133	-	19		
80 - 14 M 115	80	11	356,51	353,71	-	314	133	150	133	-	19		
84 - 14 M 115	84	11	374,33	371,54	-	332	133	150	133	-	19		
90 - 14 M 115	90	11	401,07	398,28	-	359	133	150	133	-	19		
112 - 14 M 115	112	11	499,11	496,32	-	457	133	150	133	-	19		
144 - 14 M 115	144	11	641,71	638,92	-	600	133	150	133	-	19		
												without flanges sous flasques ohne Borde sin valona	

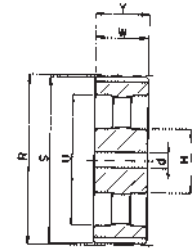

11

14 M 170

code code Code código	teeth dents Zähne dientes	type type Typ tipo	R mm	S mm	Øe mm	U mm	W mm	H mm	Y mm	Z mm	Ød mm	flange flasque Bord valona	material materiel Werkstoff material
28 - 14 M 170	28	1	124,78	122,12	134	-	187	100	202	15	-	with flanges avec flasques mit Borde con valona	cast iron - fonte - Grauguss - fundición
29 - 14 M 170	29	1	129,23	126,57	134	-	187	107	202	15	-		
30 - 14 M 170	30	1	133,69	130,99	142	-	187	107	202	15	-		
32 - 14 M 170	32	1	142,60	139,88	150	-	187	114	202	15	-		
34 - 14 M 170	34	1	151,51	148,79	158	-	187	122	202	15	-		
36 - 14 M 170	36	1	160,43	157,68	166	-	187	128	202	15	-		
38 - 14 M 170	38	1	169,34	166,60	177	-	187	141	202	15	-		
40 - 14 M 170	40	1	178,25	175,49	186	-	187	148	202	15	-		
44 - 14 M 170	44	1	196,08	193,28	209	-	187	169	202	15	-		
48 - 14 M 170	48	1	213,90	211,11	216	-	187	186	202	15	-		
56 - 14 M 170	56	2	249,56	246,76	261	207	187	160	202	15	-		
60 - 14 M 170	60	2	267,38	264,59	274	225	187	160	202	15	-		
64 - 14 M 170	64	2	285,21	282,41	288	243	187	180	202	15	-		
72 - 14 M 170	72	12	320,86	318,06	-	279	187	180	187	-	19		
80 - 14 M 170	80	12	356,51	353,71	-	314	187	180	187	-	19		
84 - 14 M 170	84	11	374,33	371,54	-	332	187	180	187	-	19		
90 - 14 M 170	90	11	401,07	398,28	-	359	187	180	187	-	19		
112 - 14 M 170	112	11	499,11	496,32	-	457	187	200	187	-	19		
144 - 14 M 170	144	11	641,71	638,92	-	600	187	220	187	-	19		
												without flanges sous flasques ohne Borde sin valona	

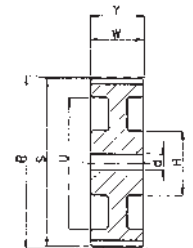

12

STANDARD «TOP DRIVE® HTD» TIMING PULLEYS FOR ASSEMBLY WITH SER-SIT® CONICAL BUSHES

POULIES DENTEES DE SERIE «TOP DRIVE® HTD» POUR MONTAGE AVEC MOYEU AMOVIBLE SER-SIT®

STANDARD-ZAHNSCHEIBEN «TOP DRIVE® HTD» ZUR MONTAGE MIT SER-SIT® SPANNBUCHSEN

POLEAS DENTADAS DE SERIE «TOP DRIVE® HTD» PARA MONTAJE CON BUJE CONICO SER-SIT®

Pitch - Pas
Teilung - Paso **5 mm**

5 M 15

code code Code código	teeth dents Zähne dientes	type type Typ tipo	R mm	S mm	Øe mm	U mm	W mm	H mm	Y mm	Z mm	SER-SIT® code	flange flasque Bord valona	material materiel Werkstoff material
B 34 - 5 M 15	34	8	54,11	52,97	57	-	22	-	22	-	1008	with flanges avec flasques mit Borde con valona	steel acier Stahl acero
B 36 - 5 M 15	36	8	57,30	56,16	62	-	22	-	22	-	1108		
B 38 - 5 M 15	38	8	60,48	59,34	67	-	22	-	22	-	1108		
B 40 - 5 M 15	40	8	63,66	62,52	73	-	22	-	22	-	1108		
B 44 - 5 M 15	44	8	70,03	68,89	73	-	22	-	22	-	1108		
B 48 - 5 M 15	48	1	76,39	75,25	84	-	20,5	64	25	4,5	1210		
B 56 - 5 M 15	56	1	89,13	87,99	94	-	20,5	70	25	4,5	1210		
B 64 - 5 M 15	64	1	101,86	100,72	108	-	20,5	78	25	4,5	1210		
B 72 - 5 M 15	72	1	114,59	113,45	121	-	20,5	90	25	4,5	1610		
B 80 - 5 M 15	80	1	127,32	126,18	131	-	20,5	92	25	4,5	1610		
B 90 - 5 M 15	90	15	143,24	142,10	-	122	20,5	92	25	4,5	1610		
B 112 - 5 M 15	112	15	178,25	177,11	-	157	20,5	92	25	4,5	1610		
B 136 - 5 M 15	136	15	216,45	215,31	-	195	20,5	110	32	5,8	2012		
B 150 - 5 M 15	150	15	238,73	237,59	-	217	20,5	110	32	5,8	2012		
												without flanges sous flasques ohne Borde sin valona	cast iron fonte Grauguss fundición

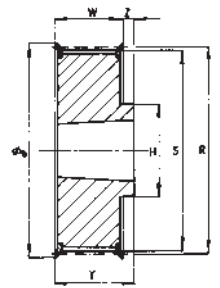

1

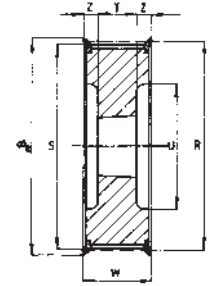

2

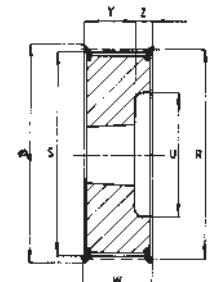

3

Pitch - Pas
Teilung - Paso **8 mm**

8 M 20

code code Code código	teeth dents Zähne dientes	type type Typ tipo	R mm	S mm	Øe mm	U mm	W mm	H mm	Z mm	Y mm	SER-SIT® code	flange flasque Bord valona	material materiel Werkstoff material
B 22 - 8 M 20	22	4	56,02	54,65	62	38	28	-	6	22	1008	with flanges avec flasques mit Borde con valona	cast iron - fonte - Grauguss - fundición
B 24 - 8 M 20	24	4	61,12	59,74	67	42	28	-	6	22	1108		
B 26 - 8 M 20	26	4	66,21	64,84	73	45	28	-	6	22	1108		
B 28 - 8 M 20	28	4	71,30	69,93	77	52	28	-	6	22	1108		
B 30 - 8 M 20	30	4	76,39	75,02	84	56	28	-	6	22	1108		
B 32 - 8 M 20	32	4	81,49	80,12	88	65	28	-	3	25	1610		
B 34 - 8 M 20	34	4	86,58	85,21	94	66	28	-	3	25	1610		
B 36 - 8 M 20	36	4	91,67	90,30	98	68	28	-	3	25	1610		
B 38 - 8 M 20	38	4	96,77	95,39	104	76	28	-	3	25	1610		
B 40 - 8 M 20	40	4	101,86	100,49	108	80	28	-	3	25	1610		
B 44 - 8 M 20	44	1	112,05	110,67	121	-	28	99	4	32	2012		
B 48 - 8 M 20	48	1	122,23	120,86	129	-	28	105	4	32	2012		
B 56 - 8 M 20	56	1	142,60	141,23	149	-	28	105	4	32	2012		
B 64 - 8 M 20	64	6	162,97	161,60	168	140	28	110	4	32	2012		
B 72 - 8 M 20	72	6	183,35	181,97	191	158	28	110	4	32	2012		
B 80 - 8 M 20	80	9	203,72	202,35	-	178	28	110	4	32	2012		
B 90 - 8 M 20	90	12	229,18	227,81	-	204	28	110	4	32	2012		

* without flanges - sous flasques - ohne Borde - sin valona

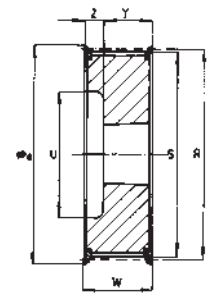

4

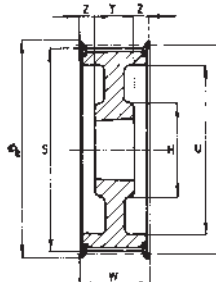

5

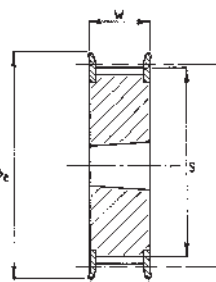

8

8 M 30

code code Code código	teeth dents Zähne dientes	type type Typ tipo	R mm	S mm	Øe mm	U mm	W mm	H mm	Z mm	Y mm	SER-SIT® code	flange flasque Bord valona	material materiel Werkstoff material
B 22 - 8 M 30	22	4	56,02	54,65	62	38	38	-	16	22	1008	with flanges avec flasques mit Borde con valona	cast iron - fonte - Grauguss - fundición
B 24 - 8 M 30	24	4	61,12	59,74	67	42	38	-	16	22	1108		
B 26 - 8 M 30	26	4	66,21	64,84	73	45	38	-	16	22	1108		
B 28 - 8 M 30	28	4	71,30	69,93	77	52	38	-	16	22	1108		
B 30 - 8 M 30	30	8	76,39	75,02	84	-	38	-	-	38	1615		
B 32 - 8 M 30	32	8	81,49	80,12	88	-	38	-	-	38	1615		
B 34 - 8 M 30	34	8	86,58	85,21	94	-	38	-	-	38	1615		
B 36 - 8 M 30	36	8	91,67	90,30	98	-	38	-	-	38	1615		
B 38 - 8 M 30	38	8	96,77	95,39	104	-	38	-	-	38	1615		
B 40 - 8 M 30	40	8	101,86	100,49	108	-	38	-	-	38	1615		
B 44 - 8 M 30	44	8	112,05	110,67	121	90	38	-	3	32	2012		
B 48 - 8 M 30	48	8	122,23	120,86	129	98	38	-	3	32	2012		
B 56 - 8 M 30	56	2	142,60	141,23	149	118	38	-	3	32	2012		
B 64 - 8 M 30	64	2	162,97	161,60	168	140	38	120	7	45	2517		
B 72 - 8 M 30	72	6	183,35	181,97	191	158	38	120	7	45	2517		
B 80 - 8 M 30	80	6	203,72	202,35	-	178	38	120	7	45	2517		
B 90 - 8 M 30	90	12	229,18	227,81	-	204	38	120	7	45	2517		
B 112 - 8 M 30	112	12	285,21	283,83	-	260	38	120	7	45	2517		
B 144 - 8 M 30	144	12	366,69	365,32	-	341	38	120	7	45	2517		
												without flanges sous flasques ohne Borde sin valona	

8 M 50

code code Code Código	teeth dents Zähne dientes	type type Typ tipo	R mm	S mm	Øe mm	U mm	W mm	H mm	Z mm	Y mm	SER-SIT® code	flange flasque Bord valona	material materiel Werkstoff material
B 28 - 8 M 50	28	2	71,30	69,93	77	52	60	-	19	22	1108	with flanges avec flasques mit Borde con valona	cast iron - fonte - Grauguss - fundición
B 30 - 8 M 50	30	4	76,39	75,02	84	58	60	-	22	38	1615		
B 32 - 8 M 50	32	4	81,49	80,12	88	60	60	-	22	38	1615		
B 34 - 8 M 50	34	4	86,58	85,21	94	66	60	-	22	38	1615		
B 36 - 8 M 50	36	4	91,67	90,30	98	68	60	-	22	38	1615		
B 38 - 8 M 50	38	4	96,77	95,39	104	75	60	-	22	38	1615		
B 40 - 8 M 50	40	2	101,86	100,49	108	80	38	-	14	32	2012		
B 44 - 8 M 50	44	2	112,05	110,67	121	90	38	-	14	32	2012		
B 48 - 8 M 50	48	2	122,23	120,86	129	100	38	-	14	32	2012		
B 56 - 8 M 50	56	2	142,60	141,23	149	120	38	-	7,5	45	2517		
B 64 - 8 M 50	64	5	162,97	161,60	168	138	60	120	7,5	45	2517		
B 72 - 8 M 50	72	5	183,35	181,97	191	158	60	120	7,5	45	2517		
B 80 - 8 M 50	80	7	203,72	202,35	-	178	60	140	4,5	51	3020		
B 90 - 8 M 50	90	7	229,18	227,81	-	204	60	146	4,5	51	3020		
B 112 - 8 M 50	112	14	285,21	283,83	-	260	60	146	4,5	51	3020		
B 144 - 8 M 50	144	14	366,69	365,32	-	341	60	146	4,5	51	3020		
B 168 - 8 M 50	168	14	427,80	426,42	-	402	60	146	4,5	51	3020		
B 192 - 8 M 50	192	14	488,92	487,54	-	462	60	146	4,5	51	3020		

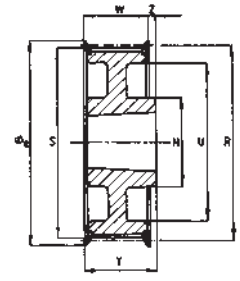

6

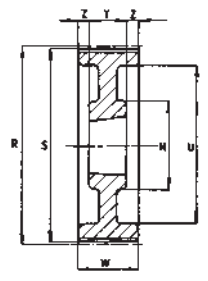

7

8 M 85

code code Code Código	teeth dents Zähne dientes	type type Typ tipo	R mm	S mm	Øe mm	U mm	W mm	H mm	Z mm	Y mm	SER-SIT® code	flange flasque Bord valona	material materiel Werkstoff material
B 34 - 8 M 85	34	2	86,58	85,21	94	66	95	-	28,5	38	1615	with flanges avec flasques mit Borde con valona	cast iron - fonte - Grauguss - fundición
B 36 - 8 M 85	36	2	91,67	90,30	98	68	95	-	28,5	38	1615		
B 38 - 8 M 85	38	2	96,77	95,39	104	75	95	-	28,5	38	1615		
B 40 - 8 M 85	40	2	101,86	100,49	108	80	95	-	31,5	32	2012		
B 44 - 8 M 85	44	2	112,05	110,67	121	90	95	-	31,5	32	2012		
B 48 - 8 M 85	48	2	122,23	120,86	129	100	95	-	25	45	2517		
B 56 - 8 M 85	56	2	142,60	141,23	149	120	95	-	25	45	2517		
B 64 - 8 M 85	64	2	162,97	161,60	168	138	95	-	25	45	2517		
B 72 - 8 M 85	72	2	183,35	181,97	191	158	95	-	22	51	3020		
B 80 - 8 M 85	80	7	203,72	202,35	-	178	95	140	22	51	3020		
B 90 - 8 M 85	90	7	229,18	227,81	-	204	95	146	22	51	3020		
B 112 - 8 M 85	112	14	285,21	283,83	-	260	95	146	22	51	3020		
B 144 - 8 M 85	144	14	366,69	365,32	-	341	95	140	9,5	76	3030		
B 168 - 8 M 85	168	14	427,80	426,42	-	402	95	140	9,5	76	3030		
B 192 - 8 M 85	192	14	488,92	487,54	-	462	95	140	9,5	76	3030		

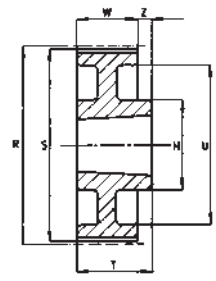

9

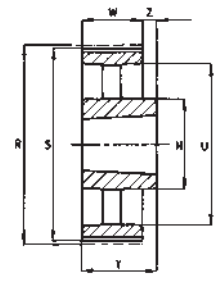

12

Pitch - Pas Teilung - Paso 14 mm

14 M 40

code code Code Código	teeth dents Zähne dientes	type type Typ tipo	R mm	S mm	Øe mm	U mm	W mm	H mm	Z mm	Y mm	SER-SIT® code	flange flasque Bord valona	material materiel Werkstoff material
B 28 - 14 M 40	28	2	124,78	122,12	134	98	54	-	11	32	2012	with flanges avec flasques mit Borde con valona	cast iron - fonte - Grauguss - fundición
B 29 - 14 M 40	29	2	129,23	126,57	134	100	54	-	11	32	2012		
B 30 - 14 M 40	30	2	133,69	130,99	142	100	54	-	11	32	2012		
B 32 - 14 M 40	32	2	142,60	139,88	150	104	54	-	11	32	2012		
B 34 - 14 M 40	34	2	151,52	148,79	158	110	54	-	4,5	45	2517		
B 36 - 14 M 40	36	2	160,43	157,68	166	120	54	-	4,5	45	2517		
B 38 - 14 M 40	38	2	169,34	166,60	177	130	54	-	4,5	45	2517		
B 40 - 14 M 40	40	2	178,25	175,49	186	138	54	-	4,5	45	2517		
B 44 - 14 M 40	44	2	196,08	193,28	209	154	54	-	1,5	51	3020		
B 48 - 14 M 40	48	2	213,90	211,11	216	172	54	-	1,5	51	3020		
B 56 - 14 M 40	56	5	249,56	246,76	261	207	54	146	1,5	51	3020		
B 64 - 14 M 40	64	5	285,21	282,41	288	243	54	146	1,5	51	3020		
B 72 - 14 M 40	72	7	320,86	318,06	-	279	54	146	1,5	51	3020		
B 80 - 14 M 40	80	14	356,51	353,71	-	314	54	146	1,5	51	3020		
B 90 - 14 M 40	90	14	401,07	398,28	-	359	54	146	1,5	51	3020		
B 112 - 14 M 40	112	14	499,11	496,32	-	457	54	146	1,5	51	3020		
B 144 - 14 M 40	144	14	641,71	638,92	-	600	54	146	1,5	51	3020		
B 168 - 14 M 40	168	14	784,66	745,87	-	705	54	146	1,5	51	3020		
B 192 - 14 M 40	192	12	855,62	852,82	-	812	54	178	35	89	3535		
B 216 - 14 M 40	216	12	962,57	959,77	-	920	54	178	35	89	3535		
B 264 - 14 M 40	264	12	1176,47	1173,67	-	1133	54	178	35	89	3535		

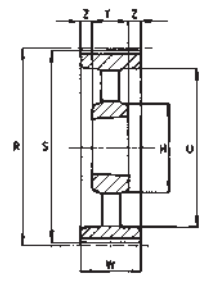

14

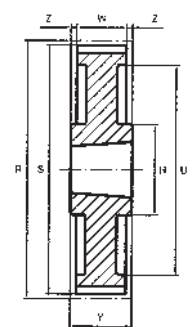

15

14 M 55

code code Code código	teeth dents Zähne dientes	type type Typ tipo	R mm	S mm	Øe mm	U mm	W mm	H mm	Z mm	Y mm	SER-SIT® code	flange flasque Bord valona	material materiel Werkstoff material
B 28 - 14 M 55	28	2	124,78	122,12	134	98	70	-	19	32	2012	with flanges avec flasques mit Borde con valona	cast iron - fonte - Grauguss - fundición
B 29 - 14 M 55	29	2	129,23	126,57	134	100	70	-	19	32	2012		
B 30 - 14 M 55	30	2	133,69	130,99	142	100	70	-	12,5	45	2517		
B 32 - 14 M 55	32	2	142,60	139,88	150	104	70	-	12,5	45	2517		
B 34 - 14 M 55	34	2	151,52	148,79	158	110	70	-	12,5	45	2517		
B 36 - 14 M 55	36	2	160,43	157,68	166	120	70	-	12,5	45	2517		
B 38 - 14 M 55	38	2	169,34	166,60	177	130	70	-	12,5	45	2517		
B 40 - 14 M 55	40	2	178,25	175,49	186	138	70	-	12,5	45	2517		
B 44 - 14 M 55	44	2	196,08	193,28	209	154	70	-	9,5	51	3020		
B 48 - 14 M 55	48	2	213,90	211,11	216	172	70	-	9,5	51	3020		
B 56 - 14 M 55	56	5	249,56	246,76	261	207	70	146	9,5	51	3020		
B 64 - 14 M 55	64	5	285,21	282,41	288	243	70	146	9,5	51	3020		
B 72 - 14 M 55	72	7	320,86	318,06	-	279	70	146	9,5	51	3020		
B 80 - 14 M 55	80	14	356,51	353,71	-	314	70	146	9,5	51	3020		
B 90 - 14 M 55	90	14	401,07	398,28	-	359	70	146	9,5	51	3020		
B 112 - 14 M 55	112	14	499,11	496,32	-	457	70	146	9,5	51	3020		
B 144 - 14 M 55	144	14	641,71	638,92	-	600	70	146	9,5	51	3020		
B 168 - 14 M 55	168	14	784,66	745,87	-	705	70	146	9,5	51	3020		
B 192 - 14 M 55	192	12	855,62	852,82	-	812	70	178	19	89	3535		
B 216 - 14 M 55	216	12	962,57	959,77	-	920	70	178	19	89	3535		
B 264 - 14 M 55	264	12	1176,47	1173,67	-	1133	70	178	19	89	3535		

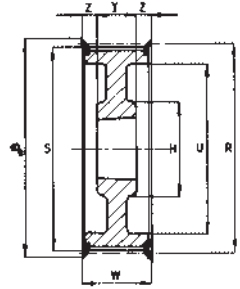
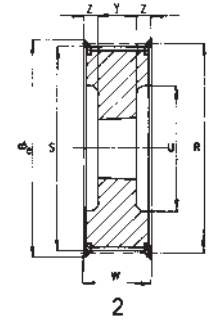

14 M 85

code code Code código	teeth dents Zähne dientes	type type Typ tipo	R mm	S mm	Øe mm	U mm	W mm	H mm	Z mm	Y mm	SER-SIT® code	flange flasque Bord valona	material materiel Werkstoff material
B 28 - 14 M 85	28	2	124,78	122,12	134	98	102	-	28,5	45	2517	with flanges avec flasques mit Borde con valona	cast iron - fonte - Grauguss - fundición
B 29 - 14 M 85	29	2	129,23	126,57	134	100	102	-	28,5	45	2517		
B 30 - 14 M 85	30	2	133,69	130,99	142	100	102	-	28,5	45	2517		
B 32 - 14 M 85	32	2	142,60	139,88	150	104	102	-	28,5	45	2517		
B 34 - 14 M 85	34	2	151,52	148,79	158	110	102	-	28,5	45	2517		
B 36 - 14 M 85	36	2	160,43	157,68	166	120	102	-	25,5	51	3020		
B 38 - 14 M 85	38	2	169,34	166,60	177	130	102	-	25,5	51	3020		
B 40 - 14 M 85	40	2	178,25	175,49	186	138	102	-	25,5	51	3020		
B 44 - 14 M 85	44	2	196,08	193,28	209	154	102	-	13	76	3030		
B 48 - 14 M 85	48	2	213,90	211,11	216	172	102	-	13	76	3030		
B 56 - 14 M 85	56	2	249,56	246,76	261	207	102	-	6,5	89	3535		
B 64 - 14 M 85	64	5	285,21	282,41	288	243	102	178	6,5	89	3535		
B 72 - 14 M 85	72	7	320,86	318,06	-	279	102	178	6,5	89	3535		
B 80 - 14 M 85	80	14	356,51	353,71	-	314	102	178	6,5	89	3535		
B 90 - 14 M 85	90	14	401,07	398,28	-	359	102	178	6,5	89	3535		
B 112 - 14 M 85	112	14	499,11	496,32	-	457	102	178	6,5	89	3535		
B 144 - 14 M 85	144	14	641,71	638,92	-	600	102	178	6,5	89	3535		
B 168 - 14 M 85	168	14	784,66	745,87	-	705	102	178	6,5	89	3535		
B 192 - 14 M 85	192	14	855,62	852,82	-	812	102	215	0	102	4040		
B 216 - 14 M 85	216	14	962,57	959,77	-	920	102	215	0	102	4040		
B 264 - 14 M 85	264	14	1176,47	1173,67	-	1133	102	215	0	102	4040		

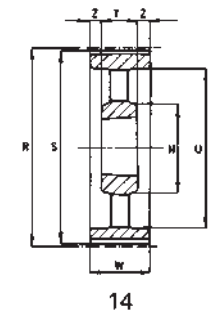
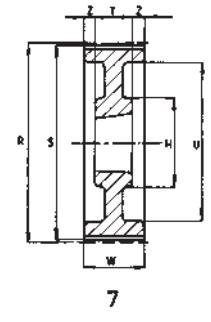

14 M 115

code code Code código	teeth dents Zähne dientes	type type Typ tipo	R mm	S mm	Øe mm	U mm	W mm	H mm	Z mm	Y mm	SER-SIT® code	flange flasque Bord valona	material materiel Werkstoff material
B 28 - 14 M 115	28	2	124,78	122,12	134	98	133	-	44	45	2517	with flanges avec flasques mit Borde con valona	cast iron - fonte - Grauguss - fundición
B 29 - 14 M 115	29	2	129,23	126,57	134	100	133	-	44	45	2517		
B 30 - 14 M 115	30	2	133,69	130,99	142	100	133	-	44	45	2517		
B 32 - 14 M 115	32	2	142,60	139,88	150	104	133	-	44	45	2517		
B 34 - 14 M 115	34	2	151,52	148,79	158	110	133	-	44	45	2517		
B 36 - 14 M 115	36	2	160,43	157,68	166	120	133	-	41	51	3020		
B 38 - 14 M 115	38	2	169,34	166,60	177	130	133	-	41	51	3020		
B 40 - 14 M 115	40	2	178,25	175,49	186	138	133	-	41	51	3020		
B 44 - 14 M 115	44	2	196,08	193,28	209	154	133	-	28,5	76	3030		
B 48 - 14 M 115	48	2	213,90	211,11	216	172	133	-	28,5	76	3030		
B 56 - 14 M 115	56	2	249,56	246,76	261	207	133	-	22	89	3535		
B 64 - 14 M 115	64	5	285,21	282,41	288	243	133	178	22	89	3535		
B 72 - 14 M 115	72	7	320,86	318,06	-	279	133	178	22	89	3535		
B 80 - 14 M 115	80	14	356,51	353,71	-	314	133	178	22	89	3535		
B 90 - 14 M 115	90	14	401,07	398,28	-	359	133	178	22	89	3535		
B 112 - 14 M 115	112	14	499,11	496,32	-	457	133	178	22	89	3535		
B 144 - 14 M 115	144	14	641,71	638,92	-	600	133	215	15,5	102	4040		
B 168 - 14 M 115	168	14	784,66	745,87	-	705	133	215	15,5	102	4040		
B 192 - 14 M 115	192	14	855,62	852,82	-	812	133	215	15,5	102	4040		
B 216 - 14 M 115	216	14	962,57	959,77	-	920	133	215	15,5	102	4040		
B 264 - 14 M 115	264	14	1176,47	1173,67	-	1133	133	267	3	127	5050		

14 M 170

code code Code código	teeth dents Zähne dientes	type type Typ tipo	R mm	S mm	Øe mm	U mm	W mm	H mm	Z mm	Y mm	SER-SIT® code	flange flasque Bord valona	material materiel Werkstoff material
B 38 - 14 M 170	38	2	169,34	166,60	177	130	187	-	55,5	76	3030	with flanges avec flasques mit Borde con valona	cast iron - fonte - Grauguss - fundición
B 40 - 14 M 170	40	2	178,25	175,49	186	138	187	-	55,5	76	3030		
B 44 - 14 M 170	44	2	196,08	193,28	209	154	187	-	49	89	3535		
B 48 - 14 M 170	48	2	213,90	211,11	216	172	187	-	49	89	3535		
B 56 - 14 M 170	56	2	249,56	246,76	261	207	187	-	49	89	3535		
B 64 - 14 M 170	64	2	285,21	282,41	288	243	187	-	42,5	102	4040		
B 72 - 14 M 170	72	7	320,86	318,06	-	279	187	215	42,5	102	4040		
B 80 - 14 M 170	80	7	356,51	353,71	-	314	187	215	42,5	102	4040		
B 90 - 14 M 170	90	14	401,07	398,28	-	359	187	215	42,5	102	4040		
B 112 - 14 M 170	112	14	499,11	496,32	-	457	187	267	30	127	5050		
B 144 - 14 M 170	144	14	641,71	638,92	-	600	187	267	30	127	5050		
B 168 - 14 M 170	168	14	784,66	745,87	-	705	187	267	30	127	5050		
B 192 - 14 M 170	192	14	855,62	852,82	-	812	187	267	30	127	5050		
B 216 - 14 M 170	216	14	962,57	959,77	-	920	187	267	30	127	5050		
B 264 - 14 M 170	264	14	1176,47	1173,67	-	1133	187	267	30	127	5050		

STANDARD METRIC PITCH TIMING PULLEYS
POULIES DENTEES DE SERIE AVEC PAS METRIQUE
STANDARD-ZAHNSCHEIBEN MIT METRISCHE TEILUNG
POLEAS DENTADAS DE SERIE CON PASO METRICO

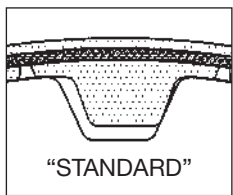

Z > 20

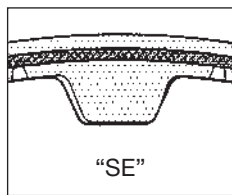

Z < 20

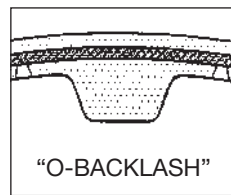

on request

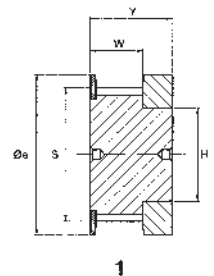

1

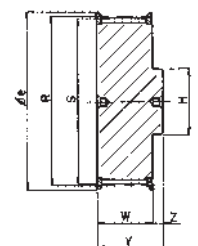

2

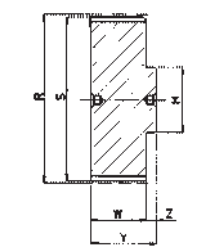

3

Pitch - Pas
 Teilung - Paso **T2,5** (6 mm)

code code Code código	teeth dents Zähne dientes	type type Typ tipo	S	Øe	H	W	Y	material materiel Werkstoff material
16 T2,5/12	12	1	9,00	12,0	6,5	9	16	Aluminium
16 T2,5/14	14	1	10,60	16,0	8,5	9	16	
16 T2,5/15	15	1	11,40	16,0	10	9	16	
16 T2,5/16	16	2	12,20	18,0	9	10	16	
16 T2,5/18	18	2	13,80	18,0	9	10	16	
16 T2,5/19	19	2	14,60	21,5	9	10	16	
16 T2,5/20	20	2	15,40	20,0	11	10	16	
16 T2,5/22	22	2	17,00	20,0	11	10	16	
16 T2,5/24	24	2	18,55	23,0	12	10	16	
16 T2,5/25	25	2	19,35	24,0	13	10	16	
16 T2,5/26	26	2	20,15	24,0	14	10	16	
16 T2,5/28	28	2	21,75	27,0	14	10	16	
16 T2,5/30	30	2	23,35	27,0	16	10	16	
16 T2,5/32	32	2	24,95	30,0	16	10	16	
16 T2,5/36	36	2	28,10	33,0	20	10	16	
16 T2,5/40	40	2	31,30	36,0	22	10	16	
16 T2,5/44	44	2	34,50	40,0	24	10	16	
16 T2,5/48	48	3	37,70	-	28	10	16	
16 T2,5/60	60	3	47,25	-	34	10	16	

Pitch - Pas
Teilung - Paso **T5** (10 mm)

mm

code code Code código	teeth dents Zähne dientes	type type Typ tipo	S	Øe	H	W	Y	material materiel Werkstoff material
21 T5/10	10	2	15,05	18	8	15	21	Aluminium Aluminium Aluminium Aluminio
21 T5/12	12	2	18,25	23	11	15	21	
21 T5/14	14	2	21,45	24	14	15	21	
21 T5/15	15	2	23,05	27	16	15	21	
21 T5/16	16	2	24,60	30	18	15	21	
21 T5/18	18	2	27,80	30	20	15	21	
21 T5/19	19	2	29,40	33	22	15	21	
21 T5/20	20	2	31,00	33	23	15	21	
21 T5/22	22	2	34,25	36	24	15	21	
21 T5/24	24	2	37,40	40	26	15	21	
21 T5/25	25	2	39,00	46	26	15	21	
21 T5/26	26	2	40,60	46	26	15	21	
21 T5/27	27	2	42,20	46	30	15	21	
21 T5/28	28	2	43,75	50	32	15	21	
21 T5/30	30	2	46,95	50	34	15	21	
21 T5/32	32	2	50,10	55	38	15	21	
21 T5/36	36	2	56,45	62	38	15	21	
21 T5/40	40	2	62,85	67	40	15	21	
21 T5/42	42	2	66,00	73	40	15	21	
21 T5/44	44	3	69,20	-	45	15	21	
21 T5/48	48	3	75,55	-	50	15	21	
21 T5/60	60	3	94,65	-	65	15	21	

Pitch - Pas
Teilung - Paso **T5** (16 mm)

mm

code code Code código	teeth dents Zähne dientes	type type Typ tipo	S	Øe	H	W	Y	material materiel Werkstoff material
27 T5/10	10	2	15,05	18	8	21	27	Aluminium Aluminium Aluminium Aluminio
27 T5/12	12	2	18,25	23	11	21	27	
27 T5/14	14	2	21,45	24	14	21	27	
27 T5/15	15	2	23,05	27	16	21	27	
27 T5/16	16	2	24,60	30	18	21	27	
27 T5/18	18	2	27,80	30	20	21	27	
27 T5/19	19	2	29,40	33	22	21	27	
27 T5/20	20	2	31,00	33	23	21	27	
27 T5/22	22	2	34,25	36	24	21	27	
27 T5/24	24	2	37,40	40	26	21	27	
27 T5/25	25	2	39,00	46	26	21	27	
27 T5/26	26	2	40,60	46	26	21	27	
27 T5/27	27	2	42,20	46	30	21	27	
27 T5/28	28	2	43,75	50	32	21	27	
27 T5/30	30	2	46,95	50	34	21	27	
27 T5/32	32	2	50,10	55	38	21	27	
27 T5/36	36	2	56,45	62	38	21	27	
27 T5/40	40	2	62,85	67	40	21	27	
27 T5/42	42	2	66,00	73	40	21	27	
27 T5/44	44	3	69,20	-	45	21	27	
27 T5/48	48	3	75,55	-	50	21	27	
27 T5/60	60	3	94,65	-	65	21	27	

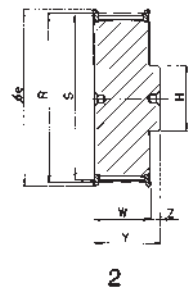

2

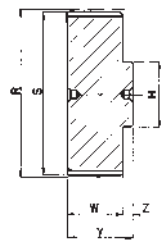

3

Pitch - Pas
Teilung - Paso **T5** (25 mm)

mm

code code Code código	teeth dents Zähne dientes	type type Typ tipo	S	Øe	H	W	Y	material materiel Werkstoff material
36 T5/10	10	2	15,05	18	8	30	36	Aluminium Aluminium Aluminium Aluminio
36 T5/12	12	2	18,25	23	11	30	36	
36 T5/14	14	2	21,45	24	14	30	36	
36 T5/15	15	2	23,05	27	16	30	36	
36 T5/16	16	2	24,60	30	18	30	36	
36 T5/18	18	2	27,80	30	20	30	36	
36 T5/19	19	2	29,40	33	22	30	36	
36 T5/20	20	2	31,00	33	23	30	36	
36 T5/22	22	2	34,25	36	24	30	36	
36 T5/24	24	2	37,40	40	26	30	36	
36 T5/25	25	2	39,00	46	26	30	36	
36 T5/26	26	2	40,60	46	26	30	36	
36 T5/27	27	2	42,20	46	30	30	36	
36 T5/28	28	2	43,75	50	32	30	36	
36 T5/30	30	2	46,95	50	34	30	36	
36 T5/32	32	2	50,10	55	38	30	36	
36 T5/36	36	2	56,45	62	38	30	36	
36 T5/40	40	2	62,85	67	40	30	36	
36 T5/42	42	2	66,00	73	40	30	36	
36 T5/44	44	3	69,20	-	45	30	36	
36 T5/48	48	3	75,55	-	50	30	36	
36 T5/60	60	3	94,65	-	65	30	36	

Pitch - Pas
Teilung - Paso **T10** (16 mm)

code code Code código	teeth dents Zähne dientes	type type Typ tipo	S	Øe	H	W	Y	material materiel Werkstoff material
31 T10/12	12	2	36,35	40	28	21	31	Aluminium
31 T10/14	14	2	42,70	46	32	21	31	
31 T10/15	15	2	45,90	50	32	21	31	
31 T10/16	16	2	49,05	55	35	21	31	
31 T10/18	18	2	55,45	62	40	21	31	
31 T10/19	19	2	58,60	67	44	21	31	
31 T10/20	20	2	61,80	67	46	21	31	
31 T10/22	22	2	68,15	73	52	21	31	
31 T10/24	24	2	74,55	80	58	21	31	
31 T10/25	25	2	77,70	84	60	21	31	
31 T10/26	26	2	80,90	88	60	21	31	
31 T10/27	27	2	84,10	88	60	21	31	
31 T10/28	28	2	87,25	94	60	21	31	
31 T10/30	30	2	93,65	98	60	21	31	
31 T10/32	32	2	100,00	108	65	21	31	
31 T10/36	36	2	112,75	118	70	21	31	
31 T10/40	40	4	125,45	129	80	21	31	
31 T10/44	44	5	138,20	-	88	21	31	
31 T10/48	48	5	150,95	-	95	21	31	
31 T10/60	60	5	189,10	-	110	21	31	

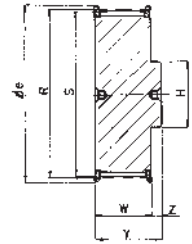

2

Pitch - Pas
Teilung - Paso **T10** (25 mm)

code code Code código	teeth dents Zähne dientes	type type Typ tipo	S	Øe	H	W	Y	material materiel Werkstoff material
40 T10/12	12	2	36,35	40	28	30	40	Aluminium
40 T10/14	14	2	42,70	46	32	30	40	
40 T10/15	15	2	45,90	50	32	30	40	
40 T10/16	16	2	49,05	55	35	30	40	
40 T10/18	18	2	55,45	62	40	30	40	
40 T10/19	19	2	58,60	67	44	30	40	
40 T10/20	20	2	61,80	67	46	30	40	
40 T10/22	22	2	68,15	73	52	30	40	
40 T10/24	24	2	74,55	80	58	30	40	
40 T10/25	25	2	77,70	84	60	30	40	
40 T10/26	26	2	80,90	88	60	30	40	
40 T10/27	27	2	84,10	88	60	30	40	
40 T10/28	28	2	87,25	94	60	30	40	
40 T10/30	30	2	93,65	98	60	30	40	
40 T10/32	32	2	100,00	108	65	30	40	
40 T10/36	36	2	112,75	118	70	30	40	
40 T10/40	40	4	125,45	129	80	30	40	
40 T10/44	44	5	138,20	-	88	30	40	
40 T10/48	48	5	150,95	-	95	30	40	
40 T10/60	60	5	189,10	-	110	30	40	

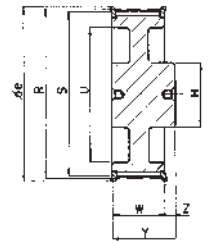

4

Pitch - Pas
Teilung - Paso **T10** (32 mm)

code code Code código	teeth dents Zähne dientes	type type Typ tipo	S	Øe	H	W	Y	material materiel Werkstoff material
47 T10/18	18	2	55,45	62	40	37	47	Aluminium
47 T10/19	19	2	58,60	67	44	37	47	
47 T10/20	20	2	61,80	67	46	37	47	
47 T10/22	22	2	68,15	73	52	37	47	
47 T10/24	24	2	74,55	80	58	37	47	
47 T10/25	25	2	77,70	84	60	37	47	
47 T10/26	26	2	80,90	88	60	37	47	
47 T10/27	27	2	84,10	88	60	37	47	
47 T10/28	28	2	87,25	94	60	37	47	
47 T10/30	30	2	93,65	98	60	37	47	
47 T10/32	32	2	100,00	108	65	37	47	
47 T10/36	36	2	112,75	118	70	37	47	
47 T10/40	40	4	125,45	129	80	37	47	
47 T10/44	44	5	138,20	-	88	37	47	
47 T10/48	48	5	150,95	-	95	37	47	
47 T10/60	60	5	189,10	-	110	37	47	

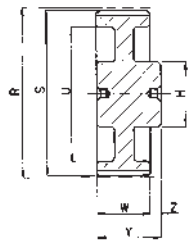

5

Pitch - Pas
Teilung - Paso **T10** (50 mm)

code code Code código	teeth dents Zähne dientes	type type Typ tipo	S	Øe	H	W	Y	material materiel Werkstoff material
66 T10/18	18	2	55,45	62	40	56	66	Aluminium
66 T10/19	19	2	58,60	67	44	56	66	
66 T10/20	20	2	61,80	67	46	56	66	
66 T10/22	22	2	68,15	73	52	56	66	
66 T10/24	24	2	74,55	80	58	56	66	
66 T10/25	25	2	77,70	84	60	56	66	
66 T10/26	26	2	80,90	88	60	56	66	
66 T10/27	27	2	84,10	88	60	56	66	
66 T10/28	28	2	87,25	94	60	56	66	
66 T10/30	30	2	93,65	98	60	56	66	
66 T10/32	32	2	100,00	108	65	56	66	
66 T10/36	36	2	112,75	118	70	56	66	
66 T10/40	40	4	125,45	129	80	56	66	
66 T10/44	44	5	138,20	-	88	56	66	
66 T10/48	48	5	150,95	-	95	56	66	
66 T10/60	60	5	189,10	-	110	56	66	

Pitch - Pas
Teilung - Paso **AT5** (10 mm)

mm

code code Code código	teeth dents Zähne dientes	type type Typ tipo	S	Øe	H	W	Y	material materiel Werkstoff material
21 AT5/12	12	2	17,85	23	11	15	21	Aluminium Aluminium Aluminium Aluminio
21 AT5/14	14	2	21,05	24	14	15	21	
21 AT5/15	15	2	22,65	27	16	15	21	
21 AT5/16	16	2	24,20	30	18	15	21	
21 AT5/18	18	2	27,40	30	20	15	21	
21 AT5/19	19	2	29,00	33	22	15	21	
21 AT5/20	20	2	30,60	33	23	15	21	
21 AT5/22	22	2	34,85	36	24	15	21	
21 AT5/24	24	2	37,00	40	26	15	21	
21 AT5/25	25	2	38,60	46	26	15	21	
21 AT5/26	26	2	40,20	46	26	15	21	
21 AT5/27	27	2	41,80	46	30	15	21	
21 AT5/28	28	2	43,35	50	32	15	21	
21 AT5/30	30	2	46,55	50	34	15	21	
21 AT5/32	32	2	49,70	55	38	15	21	
21 AT5/36	36	2	56,05	62	38	15	21	
21 AT5/40	40	2	62,45	67	40	15	21	
21 AT5/42	42	2	65,60	73	40	15	21	
21 AT5/44	44	3	68,80	-	45	15	21	
21 AT5/48	48	3	75,15	-	50	15	21	
21 AT5/60	60	3	94,25	-	65	15	21	

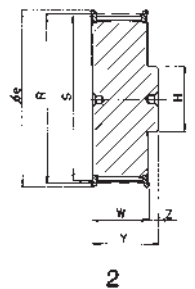

Pitch - Pas
Teilung - Paso **AT5** (16 mm)

mm

code code Code código	teeth dents Zähne dientes	type type Typ tipo	S	Øe	H	W	Y	material materiel Werkstoff material
27 AT5/12	12	2	17,85	23	11	21	27	Aluminium Aluminium Aluminium Aluminio
27 AT5/14	14	2	21,05	24	14	21	27	
27 AT5/15	15	2	22,65	27	16	21	27	
27 AT5/16	16	2	24,20	30	18	21	27	
27 AT5/18	18	2	27,40	30	20	21	27	
27 AT5/19	19	2	29,00	33	22	21	27	
27 AT5/20	20	2	30,60	33	23	21	27	
27 AT5/22	22	2	34,85	36	24	21	27	
27 AT5/24	24	2	37,00	40	26	21	27	
27 AT5/25	25	2	38,60	46	26	21	27	
27 AT5/26	26	2	40,20	46	26	21	27	
27 AT5/27	27	2	41,80	46	30	21	27	
27 AT5/28	28	2	43,35	50	32	21	27	
27 AT5/30	30	2	46,55	50	34	21	27	
27 AT5/32	32	2	49,70	55	38	21	27	
27 AT5/36	36	2	56,05	62	38	21	27	
27 AT5/40	40	2	62,45	67	40	21	27	
27 AT5/42	42	2	65,60	73	40	21	27	
27 AT5/44	44	3	68,80	-	45	21	27	
27 AT5/48	48	3	75,15	-	50	21	27	
27 AT5/60	60	3	94,25	-	65	21	27	

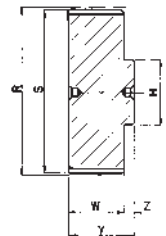

Pitch - Pas
Teilung - Paso **AT5** (25 mm)

mm

code code Code código	teeth dents Zähne dientes	type type Typ tipo	S	Øe	H	W	Y	material materiel Werkstoff material
36 AT5/12	12	2	17,85	23	11	30	36	Aluminium Aluminium Aluminium Aluminio
36 AT5/14	14	2	21,05	24	14	30	36	
36 AT5/15	15	2	22,65	27	16	30	36	
36 AT5/16	16	2	24,20	30	18	30	36	
36 AT5/18	18	2	27,40	30	20	30	36	
36 AT5/19	19	2	29,00	33	22	30	36	
36 AT5/20	20	2	30,60	33	23	30	36	
36 AT5/22	22	2	34,85	36	24	30	36	
36 AT5/24	24	2	37,00	40	26	30	36	
36 AT5/25	25	2	38,60	46	26	30	36	
36 AT5/26	26	2	40,20	46	26	30	36	
36 AT5/27	27	2	41,80	46	30	30	36	
36 AT5/28	28	2	43,35	50	32	30	36	
36 AT5/30	30	2	46,55	50	34	30	36	
36 AT5/32	32	2	49,70	55	38	30	36	
36 AT5/36	36	2	56,05	62	38	30	36	
36 AT5/40	40	2	62,45	67	40	30	36	
36 AT5/42	42	2	65,60	73	40	30	36	
36 AT5/44	44	3	68,80	-	45	30	36	
36 AT5/48	48	3	75,15	-	50	30	36	
36 AT5/60	60	3	94,25	-	65	30	36	

Pitch - Pas
Teilung - Paso **AT10** (16 mm)

mm

code code Code código	teeth dents Zähne dientes	type type Typ tipo	S	Øe	H	W	Y	material materiel Werkstoff material
31 AT10/15	15	2	45,90	50	32	21	31	Aluminium
31 AT10/16	16	2	49,05	55	35	21	31	
31 AT10/18	18	2	55,45	62	40	21	31	
31 AT10/19	19	2	58,60	67	44	21	31	
31 AT10/20	20	2	61,80	67	46	21	31	
31 AT10/22	22	2	68,15	73	52	21	31	
31 AT10/24	24	2	74,55	80	58	21	31	
31 AT10/25	25	2	77,70	84	60	21	31	
31 AT10/26	26	2	80,90	88	60	21	31	
31 AT10/27	27	2	84,10	88	60	21	31	
31 AT10/28	28	2	87,25	94	60	21	31	
31 AT10/30	30	2	93,65	98	60	21	31	
31 AT10/32	32	2	100,00	108	65	21	31	
31 AT10/36	36	2	112,75	118	70	21	31	
31 AT10/40	40	4	125,45	129	80	21	31	
31 AT10/44	44	5	138,20	-	88	21	31	
31 AT10/48	48	5	150,95	-	95	21	31	
31 AT10/60	60	5	189,10	-	110	21	31	

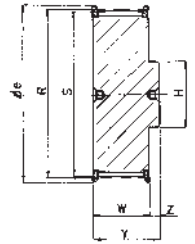

2

Pitch - Pas
Teilung - Paso **AT10** (25 mm)

mm

code code Code código	teeth dents Zähne dientes	type type Typ tipo	S	Øe	H	W	Y	material materiel Werkstoff material
40 AT10/15	15	2	45,90	50	32	30	40	Aluminium
40 AT10/16	16	2	49,05	55	35	30	40	
40 AT10/18	18	2	55,45	62	40	30	40	
40 AT10/19	19	2	58,60	67	44	30	40	
40 AT10/20	20	2	61,80	67	46	30	40	
40 AT10/22	22	2	68,15	73	52	30	40	
40 AT10/24	24	2	74,55	80	58	30	40	
40 AT10/25	25	2	77,70	84	60	30	40	
40 AT10/26	26	2	80,90	88	60	30	40	
40 AT10/27	27	2	84,10	88	60	30	40	
40 AT10/28	28	2	87,25	94	60	30	40	
40 AT10/30	30	2	93,65	98	60	30	40	
40 AT10/32	32	2	100,00	108	65	30	40	
40 AT10/36	36	2	112,75	118	70	30	40	
40 AT10/40	40	4	125,45	129	80	30	40	
40 AT10/44	44	5	138,20	-	88	30	40	
40 AT10/48	48	5	150,95	-	95	30	40	
40 AT10/60	60	5	189,10	-	110	30	40	

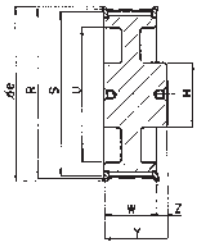

4

Pitch - Pas
Teilung - Paso **AT10** (32 mm)

mm

code code Code código	teeth dents Zähne dientes	type type Typ tipo	S	Øe	H	W	Y	material materiel Werkstoff material
47 AT10/15	15	2	45,90	50	32	37	47	Aluminium
47 AT10/16	16	2	49,05	55	35	37	47	
47 AT10/18	18	2	55,45	62	40	37	47	
47 AT10/19	19	2	58,60	67	44	37	47	
47 AT10/20	20	2	61,80	67	46	37	47	
47 AT10/22	22	2	68,15	73	52	37	47	
47 AT10/24	24	2	74,55	80	58	37	47	
47 AT10/25	25	2	77,70	84	60	37	47	
47 AT10/26	26	2	80,90	88	60	37	47	
47 AT10/27	27	2	84,10	88	60	37	47	
47 AT10/28	28	2	87,25	94	60	37	47	
47 AT10/30	30	2	93,65	98	60	37	47	
47 AT10/32	32	2	100,00	108	65	37	47	
47 AT10/36	36	2	112,75	118	70	37	47	
47 AT10/40	40	4	125,45	129	80	37	47	
47 AT10/44	44	5	138,20	-	88	37	47	
47 AT10/48	48	5	150,95	-	95	37	47	
47 AT10/60	60	5	189,10	-	110	37	47	

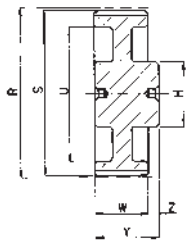

5

Pitch - Pas
Teilung - Paso **AT10** (50 mm)

mm

code code Code código	teeth dents Zähne dientes	type type Typ tipo	S	Øe	H	W	Y	material materiel Werkstoff material
66 AT10/15	15	2	45,90	50	32	56	66	Aluminium
66 AT10/16	16	2	49,05	55	35	56	66	
66 AT10/18	18	2	55,45	62	40	56	66	
66 AT10/19	19	2	58,60	67	44	56	66	
66 AT10/20	20	2	61,80	67	46	56	66	
66 AT10/22	22	2	68,15	73	52	56	66	
66 AT10/24	24	2	74,55	80	58	56	66	
66 AT10/25	25	2	77,70	84	60	56	66	
66 AT10/26	26	2	80,90	88	60	56	66	
66 AT10/27	27	2	84,10	88	60	56	66	
66 AT10/28	28	2	87,25	94	60	56	66	
66 AT10/30	30	2	93,65	98	60	56	66	
66 AT10/32	32	2	100,00	108	65	56	66	
66 AT10/36	36	2	112,75	118	70	56	66	
66 AT10/40	40	4	125,45	129	80	56	66	
66 AT10/44	44	5	138,20	-	88	56	66	
66 AT10/48	48	5	150,95	-	95	56	66	
66 AT10/60	60	5	189,10	-	110	56	66	

STANDARD TIMING BARS
BARRES DENTEES DE SERIE
STANDARD-ZAHNSTANGEN
BARRAS DENTADAS DE SERIE

T5 (5 mm)

Teeth Dents Zähne Dientes	Dp (mm)	L (mm)
10	15,91	140
11	17,50	140
12	19,10	140
13	20,69	140
14	22,28	140
15	23,87	140
16	25,47	140
17	27,06	140
18	28,65	140
19	30,24	140
20	31,83	160
21	33,42	160
22	35,01	160
23	36,61	160
24	38,19	160
25	39,79	160
26	41,38	160
27	42,97	160
28	44,56	160
29	46,16	160
30	47,15	160
32	50,93	160
34	54,11	160
35	55,71	160
36	57,30	160
37	58,89	160
38	60,48	160
40	63,66	160
42	68,85	160
44	70,03	160
45	71,62	160
46	73,21	160
48	76,39	160
50	79,58	160
60	95,49	160
72	114,59	160
80	127,32	160
90	143,24	160
100	159,15	160

T10 (10 mm)

Teeth Dents Zähne Dientes	Dp (mm)	L (mm)
10	31,83	140
11	35,01	140
12	38,19	140
13	41,38	140
14	44,56	160
15	47,74	160
16	50,93	160
17	54,11	160
18	57,29	160
19	60,47	160
20	63,66	160
21	66,84	160
22	70,02	160
23	73,21	160
24	76,39	160
26	82,76	160
28	89,12	160
30	95,49	160
32	101,85	160
34	108,22	160
36	114,59	160
38	120,95	160
40	127,32	160
45	143,23	160
48	152,78	160
60	190,98	160
72	229,17	160

Material: Aluminium
 Materiel: Aluminium
 Werkstoff: Aluminium
 Material: Aluminio

XL (1/5")

Teeth Dents Zähne Dientes	Dp (mm)	L (mm)
10	16,17	140
11	17,79	140
12	19,40	140
13	21,02	140
14	22,64	140
15	24,25	140
16	25,87	140
17	27,49	140
18	29,11	140
19	30,72	140
20	32,34	140
21	33,96	160
22	35,57	160
23	37,19	160
24	38,81	160
25	40,43	160
26	42,04	160
27	43,66	160
28	45,28	160
29	46,89	160
30	48,51	160
32	51,74	160
33	53,36	160
34	54,98	160
35	56,60	160
36	58,21	160
38	61,45	160
39	63,06	160
40	64,68	160
41	66,30	160
42	67,91	160
43	69,53	160
44	71,15	160
48	77,62	160
56	90,55	160
60	97,02	160
72	116,43	160

L (3/8")

Teeth Dents Zähne Dientes	Dp (mm)	L (mm)
10	30,32	140
11	33,35	140
12	36,38	160
13	39,41	160
14	42,45	160
15	45,48	160
16	48,51	160
17	51,54	160
18	54,57	160
19	57,61	160
20	60,64	160
21	63,67	160
22	66,70	160
23	69,73	160
24	72,77	160
27	81,86	160
30	90,96	160

Material: Aluminium/Steel
 C 40 (for XL Steel C 40 only
 on request)

Materiel: Aluminium/Acier
 C 40 (pour XL Acier C 40 sur
 demande)

Werkstoff: Aluminium/Stahl
 C 40 (für XL Stahl C 40 nur
 nach anfrage)

Material: Aluminio/Acero C 40
 (para XL Acero C 40 sobre
 demanda)

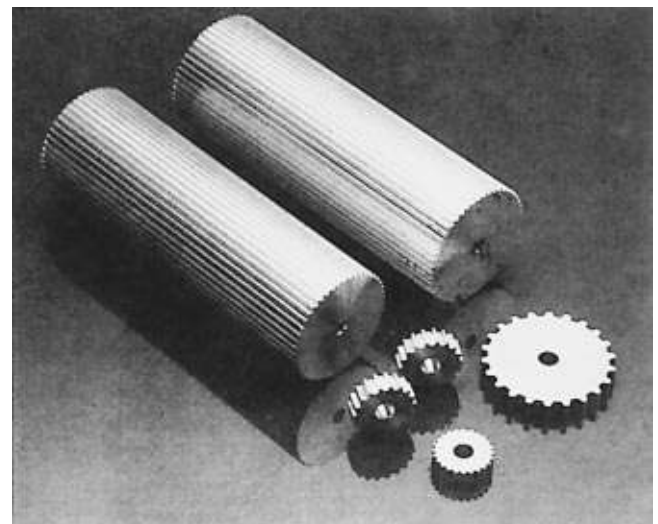
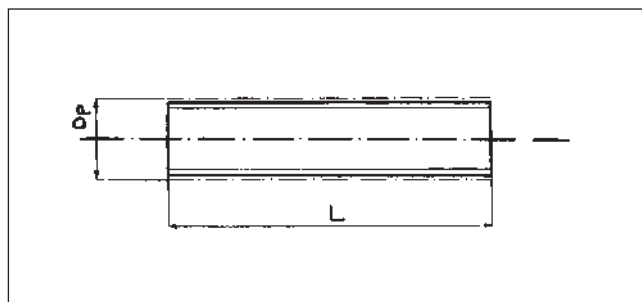

AT5 (5 mm)

Teeth Dents Zähne Dientes	Dp (mm)	L (mm)
12	19,10	140
13	20,69	140
14	22,28	140
15	23,87	140
16	25,47	140
17	27,06	140
18	28,65	140
19	30,24	140
20	31,83	160
21	33,42	160
22	35,01	160
23	36,61	160
24	38,19	160
25	39,79	160
26	41,38	160
27	42,97	160
28	44,56	160
29	46,16	160
30	47,15	160
32	50,93	160
34	54,11	160
35	55,71	160
36	57,30	160
37	58,89	160
38	60,48	160
40	63,66	160
42	68,85	160
44	70,03	160
45	71,62	160
46	73,21	160
48	76,39	160
50	79,58	160
60	95,49	160
72	114,59	160

AT10 (10 mm)

Teeth Dents Zähne Dientes	Dp (mm)	L (mm)
14	44,56	160
15	47,74	160
16	50,93	160
17	54,11	160
18	57,29	160
19	60,47	160
20	63,66	160
21	66,84	160
22	70,02	160
23	73,21	160
24	76,39	160
26	82,76	160
28	89,12	160
30	95,49	160
32	101,85	160
34	108,22	160
36	114,59	160
38	120,95	160
40	127,32	160
45	143,23	160
48	152,78	160
60	190,98	160
72	229,17	160

Material: Aluminium
 Materiel: Aluminium
 Werkstoff: Aluminium
 Material: Aluminio

Note:

Super Torque 3 mm, 4,5 mm and 5 mm timing bars can be manufactured on request.

Les barres dentées Super Torque 3 mm, 4,5 mm et 5 mm peuvent être fabriquées sur demande.

Super Torque 3 mm, 4,5 mm und 5 mm Zahnstangen können nach anfrage gefertigt werden.

Sobre demanda podemos construir barras dentadas Super Torque 3 mm, 4,5 mm y 5 mm.

TOP DRIVE® HTD 3 mm and 5 mm timing bars can be manufactured on request.

Les barres dentées TOP DRIVE® HTD 3 mm et 5 mm peuvent être fabriquées sur demande.

TOP DRIVE® HTD 3 mm und 5 mm Zahnstangen können nach anfrage gefertigt werden.

Sobre demanda podemos construir barras dentadas TOP DRIVE® HTD 3 mm y 5 mm.

FLANGES FLASQUES BORDSCHEIBEN VALONAS

Type Type Typ Tipo	Di mm	Dc mm	De mm	S mm	XL	L	H	XH	XXH	T20	8 mm	14 mm	S mm	3 mm	S mm	4,5 mm	5 mm	T2,5	T5 AT5	T10 AT10
Number of teeth - Numero de dents - Anzahl der Zähne - Numero dientes																				
0/0	6,5	-	12	0,6									0,5	10	1			12-13		
0/1	8,5	-	16	1									0,5	12-13	1			14-15		
0/2	10	-	18	1									0,5	14	1			16-17-18	10	
0/3	12,5	-	21,5	1									0,5		1	12		19		
0/4	9	-	16	1									0,5	15	1					
1	13	17	20	1	10-11								0,5	16-18-19	1	13		20-21-22	11	
1/1	15	19	23	1									0,5	20	1		12	24	12	
2	16	21	24	1	12-13								0,5	21	1	14-15	14	25-36	14	
2/1	17	22	25	1									0,5	22-23	1					
3	19	24	27	1	14-15								0,5	24-26	1	16-17	15-16	28-29-30	15	
3/1	21	26,5	29,5	1									0,5		1					
4	22	27	30	1	16-17								0,5	27-28-29	1	18-19	17-18	32-33-34	16-17-18	
5	25	30	33	1,5	18	10							0,5	30-31-32	1	20-21	20	35-36-37	19-20	
6	28	32	36	1,5	19-20	11							0,5	33-34-35	1	22-23	21-22	38-39-40	21-22	
6/1	31	-	37	1,5									0,5		1					
7	31	36	40	1,5	21-22-23	12							0,5	36-39	1	25-26	24	42-44	24	12
7/1	34	40	47	1,5							16-17		0,5		1	27-28				13
8	35	42	46	1,5	24-25-26	14							0,5	40-42-44	1	29	26		25-26-27	14
8/1	36	45	50	1,5							18		0,5		1	30-31				
9	39	46	50	1,5	27-28-29	15	12				19		0,5		1	32-33	28-29-30		28-29-30	15
9/1	41	50	55	1,5							20		0,5		1	34				
10	43	48	55	1,5	30	16-17					21		0,5		1	35-36	32		31-32-33	16
10/1	47	52	57	1,5	32								0,5		1					
11	47	55	62	1,5	35-36	18-19	14				22-23		0,5		1	37-38	36		34-36	17-18
11/1	51	61	67	1,5			15						0,5	64	1	39-40				
12	53	60	67	1,5			16				24-25		0,5		1	41	40		37-38-40	19-20
13	56	65	73	1,5	40-42	22-23					26-27		0,5		1				41-42	21-22
13/1	60	70	77	1,5	44		17				28		0,5		1					23
14	64	72	80	1,5		24-25	18				29		0,5		1					24
15	68	79	84	1,5	48		19				30-31		0,5		1					25
16	71	80	88	1,5		26-27	20				32-33		0,5		1					26-27
16/1	75	84	90	1,5									0,5		1					
17	78	88	94	1,5	52	28-29	21-22				34-35		0,5		1					28-29
18	80	90	98	1,5	57	30	23				36		0,5		1					30
19	83	94	100	1,5		31-32				15	37		0,5		1			60		31
20	88	96	104	1,5			24-25				38-39		0,5		1		60			
20/1	90	101	108	1,5	60	33					40		0,5		1		64			
21	93	102	108	1,5		34	26				41		0,5		1					32-33
21/1	94	106	111	1,5							42		0,5		1				66	
22	96	105	113	1,5		35-36	27				43		0,5		1			68		34-35
23	102	112	118	1,5		37	28			18			0,5		1					36
24	104	113	121	1,5	72	38-39	29				44-45		0,5		1					37
24/1	105	120	127	1,5							46-47		0,5		1					38
25	108	125	134	2,5				18				28-29	0,5		1					
26	112	121	129	1,5		40-41	30				48-49		0,5		1					39-40
26/1	115	126	131	1,5			31				50		0,5		1					
27	115	132	142	2,5							19		0,5		1					
28	120	128	137	1,5		42-43	32-33				21	51-52	0,5		1					
29	122	138	150	2,5							20		0,5		1					
30	126	136	150	1,5		44-45	34				22	53-54	0,5		1				86	
31	130	140	145	1,5		46	35					55	0,5		1					
32	130	146	158	2,5							21		0,5		1					
33	134	141	149	1,5		47					23	56-57	0,5		1					
34	135	145	151	1,5		48	36					58	0,5		1					
34/1	142	154	158	1,5		49	37				24	59-60-61	0,5		1					
35	136	153	166	2,5				22-23					0,5		1					
36	143	152	158	1,5		50-51	38				25	62	0,5		1					
36/1	148	158	166	1,5		52	39						0,5		1					
37	149	167	177	2,5							24		0,5		1					
38	151	160	168	1,5		53-54	40				26	63-64-65	0,5		1					
39	156	176	186	2,5							25	18	0,5		1					
40	158	167	175	1,5		55-56	41-42				27	66-67	0,5		1					
40/1	161	176	182	1,5							28	68-69-70	0,5		1					
41	165	181	191	2,5							26		0,5		1					
42	166	176	182	1,5		57-58	43						0,5		1					
42/1	170	184	191	1,5			44				29-30	71-72	0,5		1					
43	166	188	200	2,5							27	19	0,5		1					
44	172	177	189	1,5		59-60	45-46						0,5		1					
45	177	197	209	2,5							20		0,5		1					
46	182	193	199	1,5			47-48				28		0,5		1					
47	180	195	202	1,5			49-50				31-32		0,5		1					
48	194	210	216	2,5			51-52-53	30	21			48	0,5		1					
49	208	224	232	2,5			54-55-56	32	22			50	0,5		1					
50	222	238	261	2,5			57-58-59	34	24			54-55	0,5		1					
51	232	252	261	2,5			60-61	36	25			56-57	0,5		1					
51/1	238	261	272	2,5			62-63		26			58-59	0,5		1					
52	250	266	274	2,5			64-65-66	38				60	0,5		1					
52/1	260	277	288	2,5			67-68	40	28			62	0,5		1					
53	264	280	288	2,5		90	69-70					63-64	0,5		1					

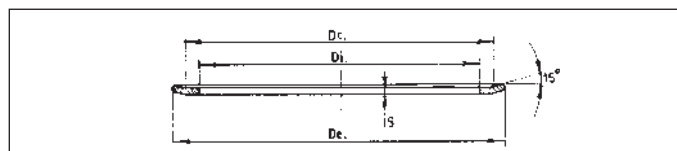

ALUMINIUM CLAMPING PLATES FOR TIMING BELTS
PLAQUES TENDEUSES EN ALUMINIUM POUR COURROIES OUVERTES
ALUMINIUM SPANPLATTEN FÜR ZAHNRIEMENENDEN
LAMINAS TENSORAS IN ALUMINIO PARA CORREAS A METROS

Pitch Pas Teilung Paso	b	d	e	L	H	Belt width - Largeur courroie - Riemen Breite - Anchura correa A (mm)					
						6	10	16	25	32	50
						B					
T5	6	5,5	3,4	41,8	8	-	29	35	44	-	-
AT5	6	5,5	3,4	41,8	8	-	29	35	44	-	-
T10	8	9	5	80	15	-	-	41	50	57	75
AT10	8	9	5	80	15	-	-	41	50	57	75

Pitch Pas Teilung Paso	b	d	e	L	H	Belt width - Largeur courroie - Riemen Breite - Anchura correa A (mm)					
						0,25	031*	037	050	075	100
						B					
XL	6	5,5	3,5	42,5	8	25,5	27	28,5	-	-	-
L	8	9	5	76,6	15	-	-	-	39	45	51,5
H	10	11	9	106,9	22	-	-	-	45	51	57,5

Pitch Pas Teilung Paso	b	d	e	L	H	Belt width - Largeur courroie - Riemen Breite - Anchura correa A (mm)			
						6	9	15	25
						B			
3M	5	4,5	2	25	5	21	24	30	-
5M	6	5,5	3,4	41,8	8	-	28	34	44

Pitch Pas Teilung Paso	b	d	e	L	H	Belt width - Largeur courroie - Riemen Breite - Anchura correa A (mm)									
						15	20	25	30	40	50	55	85	115	170
						B									
8M	8	9	5	66	15	40	45	-	55	-	75	-	110	-	-
14M	10	11	9	116	22	-	-	-	-	71	-	86	116	146	201

How to order

Designation

Bestell bei spiel

Identificacion

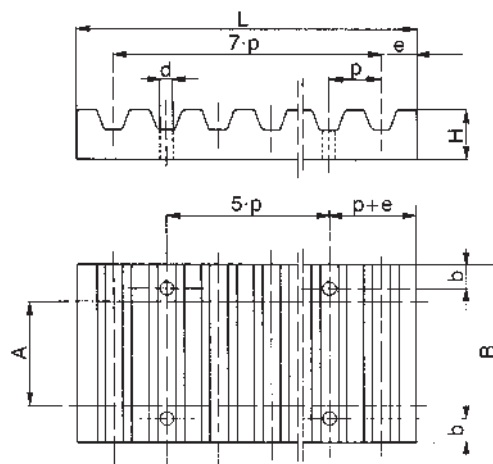

SER-SIT® TAPER LOCK BUSHING

SER-SIT® taper lock bush is designed to give the following:

- 1) perfect assembly;
- 2) rapid dismantling of the pulley and other transmission equipment;
- 3) no special tools requirement except hexagonal key.

The large range of finished bores available ensures that an immediate assembly can be made thus avoiding costly factory down-time.

The bushes are machined with keyways in accordance with UNI and DIN specifications. This is in addition to clamping screws which, in many cases, are sufficient to meet the required torque.

Fastening by SER-SIT® bushes allows the removal of any clearance between hub and bore so that fretting corrosion is positively eliminated. SER-SIT® bushes are interchangeable with all similar types sold throughout the world.

MOYEU AMOVIBLE SER-SIT®

Les moyeux amovibles SER-SIT® permettent un montage techniquement parfait et un démontage rapide des poulies (ainsi que de nombreux organes de transmission) à l'aide uniquement d'une clef hexagonale. La gamme étendue des alésages finis disponibles permet un montage immédiat et économique.

Les moyeux amovibles sont prévus avec rainures de clavettes aux normes DIN et UNI; pour de faibles puissances le serrage du moyeu sur l'arbre est suffisant pour transmettre le couple. Le montage à l'aide des moyeux amovibles SER-SIT® permet d'éliminer le jeu entre l'arbre et l'alésage, ce qui évite la formation de rouille de contact (fretting corrosion).

Les moyeux amovibles SER-SIT® sont interchangeables avec tous les types de moyeux amovibles analogues répandus dans le monde entier.

SER-SIT® SPANNBUCHSEN

SER-SIT® Spannbuchsen sind für folgende Eigenschaften entwickelt:

- 1) Perfekte Montage;
- 2) Schnelles Entfernen der Scheiben und anderer Antriebs-elemente;
- 3) Erfordern kein Spezialwerkzeug, außer einem Imbus-Schlüssel.

Die breite Herstellungspalette der verfügbaren Bohrungen stellt sicher, daß eine sofortige Montage erfolgen kann, hierdurch werden kostspielige Maschinenstandzeiten vermieden. Die Buchsen sind gemäß UNI und DIN Normen mit Paßfedernuten gefertigt, zusätzlich zu den Klemmschrauben, die in vielen Fällen ausreichend sind, um die geforderte Spannung zu erreichen.

SER-SIT® Spannbuchsen können in beliebiger Position auf der Welle montiert werden, so daß Passungsrost weitgehend ausgeschlossen wird.

SER-SIT®-Buchsen sind austauschbar mit allen ähnlichen marktgängigen Typen.

CASQUILLO CONICO SER-SIT®

Los casquillos cónicos SER-SIT® permiten un montaje técnicamente perfecto y un desmontaje de la polea (o otros elementos de transmisión) en un tiempo muy corto y sin necesidad de otro utensilio que una llave exagonal. La amplia gama de casquillos con el taladro terminado disponibles asegura un montaje inmediato sin esperar la mecanización en taller externo o interno con su correspondiente costo.

Los casquillos están terminados en el interior para la claveta correspondiente según normas DIN y UNI, aunque en muchos casos basta la presión ejercida al apretar los tornillos para transmitir el par requerido. La fijación mediante casquillo cónico SER-SIT® permite eliminar cualquier juego entre el eje y el taladro de modo que evita definitivamente la formación del exido de contacto (fretting corrosion).

El casquillo cónico SER-SIT® es intercambiable con los tipos de casquillos análogos difundidos por todo el mundo.



type type Typ tipo	Diameter of the bore Diamètre des alésage Bohrungsdurchmesser Diámetro del agujero		Bush - Moyeu Buchse - Casquillo		Screws - Vis Schrauben - Tornillos				
			length longeur Länge longitud [mm]	max. diameter max. diametre max. Durchmesser max. diámetro [mm]	n°	withworth	length longeur Länge longitud [mm]	set screw wrench type clef hexagonale type Imbus- Schlüssel Typ llave exagonal tipo	Ms [Nm]
1008 (25.20)	mm inches	11 12 14 15 16 18 19 20 22 24 25 3/4 3/8 1/2 5/8 3/4 7/8 1	22,3	35	2	1/4	13	3	5,5
1108 (28.20)	mm inches	11 12 14 15 16 17 18 19 20 22 24 25 26 27 28 3/8 1/2 5/8 3/4 7/8 1 1 1/8	22,3	38	2	1/4	13	3	5,5
1210 (30.25)	mm inches	11 12 14 15 16 18 19 20 22 24 25 26 28 30 32 1/2 5/8 3/4 7/8 1 1 1/8 1 1/4 1 1/2	25,4	47	2	3/8	16	5	20
1215 (30.40)	mm inches	12 14 15 16 18 19 20 22 24 25 26 28 30 32 1/2 5/8 3/4 7/8 1 1 1/8 1 1/4	38,1	47	2	3/8	16	5	20
1310 (35.25)	mm inches	14 16 18 19 20 22 24 25 28 30 32 35 1/2 5/8 3/4 7/8 1 1 1/8 1 1/4 1 3/8	25,4	52	2	3/8	16	5	20
1610 (40.25)	mm inches	12 14 15 16 18 19 20 22 24 25 26 28 30 32 35 38 40 42 3/8 1/2 5/8 3/4 7/8 1 1 1/8 1 1/4 1 3/8 1 1/2 1 5/8	25,4	57	2	3/8	16	5	20
1615 (40.40)	mm inches	12 14 15 16 18 19 20 22 24 25 26 28 30 32 35 38 40 42 1/2 5/8 3/4 7/8 1 1 1/8 1 1/4 1 3/8 1 1/2 1 5/8 1 3/4	38,1	57	2	3/8	16	5	20
2012 (50.30)	mm inches	14 15 16 18 19 20 22 24 25 26 28 30 32 35 38 40 42 45 48 50 5/8 3/4 7/8 1 1 1/8 1 1/4 1 3/8 1 1/2 1 5/8 1 3/4 1 7/8 2	31,8	70	2	7/16	22	5	20
2517 (65.45)	mm inches	18 19 20 22 24 25 28 30 32 35 38 40 42 45 48 50 55 60 65 3/4 7/8 1 1 1/8 1 1/4 1 3/8 1 1/2 1 5/8 1 3/4 1 7/8 2 2 1/8 2 1/4 2 3/8 2 1/2	44,5	85	2	1/2	25	6	50
3020 (75.50)	mm inches	22 25 28 30 32 35 38 40 42 45 48 50 55 57 60 65 70 75 1 1/4 1 3/8 1 1/2 1 5/8 1 3/4 1 7/8 2 2 1/8 2 1/4 2 3/8 2 1/2 2 5/8 2 3/4 2 7/8 3	50,8	108	2	5/8	32	8	90
3030 (75.75)	mm inches	42 45 47 48 50 55 60 65 70 75 1 1/4 1 3/8 1 1/2 1 5/8 1 3/4 1 7/8 2 2 1/8 2 1/4 2 3/8 2 1/2 2 5/8 2 3/4 2 7/8 3	76,2	108	2	5/8	32	8	90
3535 (90.90)	mm inches	25 35 38 40 42 45 48 50 55 60 65 70 75 80 85 90 1 1/2 1 5/8 1 3/4 1 7/8 2 2 1/8 2 1/4 2 3/8 2 1/2 2 5/8 2 3/4 2 7/8 3 3 1/8 3 1/4 3 3/8 3 1/2	88,9	127	3	1/2	38	10	115
4040 (100.100)	mm inches	45 50 55 60 65 70 75 80 85 90 95 100 1 3/4 2 2 3/4 3 1/2 3 3/4 4	101,6	146	3	5/8	44	14	170
4545 (115.115)	mm inches	55 60 65 70 75 80 85 90 95 100 105 110 3 3 1/2 4	114,3	162	3	3/4	51	14	195
5050 (125.125)	mm inches	50 60 65 70 75 80 85 90 95 100 110 115 120 125 3 1/2 4	127	178	3	7/8	57	17	275

The first group of numbers indicates maximum bore, the second conventional length in mm.

Bore diameters in bold type are made in steel instead of cast iron.

Ms = screw tightening torque

Le premier groupe de chiffres indique l'alésage maxi, le deuxième la longueur conventionnelle en mm.

Les diamètres des alésages imprimés en gras sont construits en acier, les autres types normalment fournis en fonte

Ms = couple de serrage des vis

In der ersten Spalte wird die max. Bohrung, in der zweiten Spalte die übliche Länge angegeben.

Die fettgedruckten Bohrungsdurchmessern bezeichnen die Stahlbuchsen.

Ms = Festzieh-Drehmoment der Schrauben

El primer grupo de cifras indica el agujero máximo y el segundo la longitud convencional en mm.

Los diámetros de agujero indicados en negrita indica los casquillos fabricados en acero, siendo normalmente los otros suministrados en fundición.

Ms = par de apriete del tornillo

Keyway, Rainures, Paßfedernut, Alojamiento chaveta en buje: UNI 6604-69 / DIN 6885		
bore diameter alésage Bohrung bujes [mm]	b [mm]	t ₂ [mm]
10÷12	4	1,8
13÷17	5	2,3
18÷22	6	2,8
23÷30	8	3,3
31÷38	10	3,3
39÷44	12	3,3
45÷50	14	3,8
51÷58	16	4,3
59÷65	18	4,4
66÷75	20	4,9
76÷85	22	5,4
86÷95	25	5,4
96÷110	28	6,4
111÷130	32	7,4

Reduced keyway only when the undermentioned bores are the maximum bores and only in the bushing types shown in table.
Rainures réduites pour les alésages maxi. uniquement pour moyeux ci-dessous.
Reduzierte Paßfedernutenhöhe nur anwendbar bei max. Bohrungsdurchmesser und bei den unten genannten Buchsentypen.
Alojamiento chaveta reducida solo en caso en que el taladro indicado sea el agujero máximo, y solo en los casquillos sub-arralados.

bore diameter alésage Bohrung bujes [mm]	bushing type moyeu type Buchsentype tipo de casquillo	b [mm]	t ₂ [mm]
28	1108	8	2,3
32	1210 - 1215	10	2,3
40/42	1610 - 1615	12	2,3

Keyway on SER-SIT® taper bush (B.S. 46)
 Rainures des moyeux amovibles SER-SIT® (B.S. 46)
 Paßfedernut für Taper-spannbuchsen SER-SIT® (B.S. 46)
 Alojamiento chaveta en casquillo conico SER-SIT® (B.S. 46)

bore diameter - alésage Bohrung - agujero [inches]	b [inches]	t ₂ [inches]
3/8÷1/2	1/8	1/16
9/16÷3/4	3/16	3/32
13/16÷1	1/4	1/8
1/16÷1-1/4	5/16	1/8
1-5/16÷1-1/2	3/8	1/8
1-5/8÷1-3/4	7/16	5/32
1-7/8÷2	1/2	5/32
2-1/8÷2-1/2	5/8	7/32
2-5/8÷3	3/4	1/4
3-1/8÷3-1/2	7/8	5/16
3-3/4÷4	1	3/8
4-1/4÷5	1-1/4	7/16

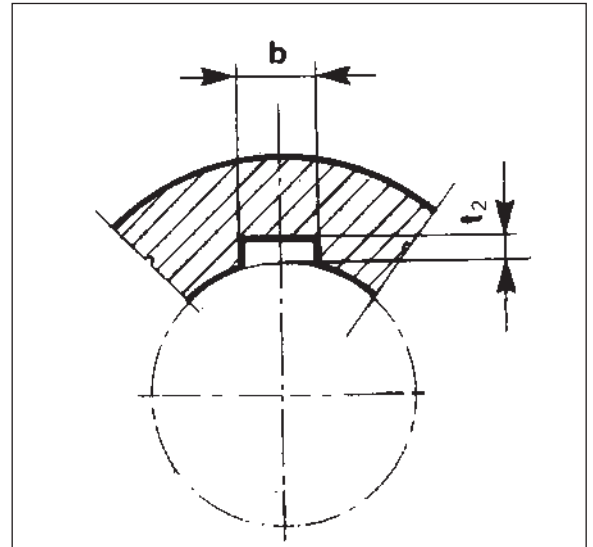

Assembly and dismantling of SER-SIT® conical bushing

- Before fitting the bushing, carefully clean the bore and conical parts.
- Fit the bushing into the pulley, taking care to let the threaded half-holes of the pulley coincide with the unthreaded holes of the bushing.
- Hand tighten the screws.
- Fit the pulley to the hub after carefully cleaning it. Position it and tighten the screws alternately.
- Dismantling: remove screws and replace one screw in the jacking hole provided and tighten until hub is released.

NOTE - Ensure that the key does not bottom in the keyway. Clearance in recommended in the keyway bottom.

Montage et démontage des moyeux amovibles SER-SIT®

- Avant de placer le moyeu amovible dans la poulie, nettoyez soigneusement son logement et l'alésage.
- Placer le moyeu amovible dans la poulie, en faisant attention de faire coïncider les demi-alésages filetés de la poulie, avec les demi-alésages non filetés du moyeu amovible.
- Engager les vis a la main sans les serrer.
- Présenter le tout sur l'arbre, après l'avoir nettoyé soigneusement, mettre en position et serrer les vis alternativement.
- Pour démonter: Retirer les vis et engager l'une d'elles dans l'alésage libre en visant à fond jusqu'à déblocage du moyeu.

N.B. - Le sommet de la clavette ne doit pas être en contact avec le fond de son logement dans le moyeu - vérifier qu'il subsiste un jeu.

Montage und Demontage der SER-SIT® Spannbuchsen

- Von der Montage der Buchse sind die Bohrungen und die konischen Teile sorgfältig zu reinigen.
- Die Buchse in die Scheibe einsetzen und die geschnittenen Halb-bohrungen der Scheibe mit den ungeschnittenen Halbbohrungen der Buchse zusammenfallen lassen.
- Die Schrauben mit der Hand anziehen.
- Nach sorgfältiger Reinigung setzen Sie die Nabe der Scheibe auf die Welle. Richten Sie die Scheibe aus und befestigen Sie die Schrauben gleichmäßig.
- Demontieren Sie die Schrauben, setzen Sie eine Schraube in das vorhandene Gewinde der Abziehvorrückung ein, und drehen Sie die Schraube bis die Scheibe sich löst.

ANMERKUNG: Stellen Sie sicher, daß die Schraube nicht bis zum Ende des Sachgewindeloches vordringt.

Montaje y desmontaje del casquillo cónico SER-SIT®

- Antes de colocar el casquillo cónico en la polea limpiar cuidadosamente los alojamientos.
- Colocar el casquillo en la polea, haciendo coincidir el medio taladro roscado de la polea con el medio taladro sin roscado del casquillo.
- Colocar los tornillos a mano sin apretarlos.
- Presentar el conjunto sobre el eje, después de haberlo limpiado, colocarlo en posición y apretar los tornillos alternativamente.
- Para desmontar: sacar los tornillos y atornillar uno de ellos em los roscados libres, roscando a fondo hasta el desbloqueo del casquillo.

NOTA - El dorso de la chaveta no debe estar en contacto con el fondo de su alojamiento en el casquillo. Verificar que exista un juego.